

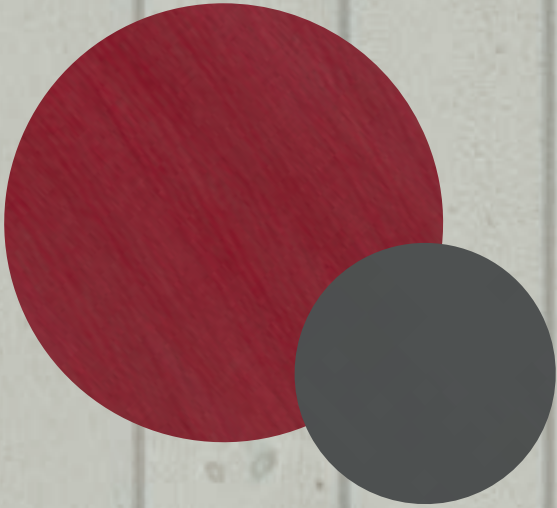

2025



Coating systems for wood and more

Knowledge and advice

Our coating systems

Advice

- 4 How our quality standards start your rockets
- 5 A network of strong partners
- 6-7 Wood meets colour

Knowledge

- 8-9 Practical knowledge about wood processing, care and renovation
- 10-11 Wood protection
- 12-13 Sanding sequence for oiled surfaces
- 14-15 Maintenance and care for wooden flooring in indoor areas
- 16-17 Maintenance and care for timber decking and cladding in outdoor areas



Interior

20-21	Osmo recommends
22-23	Product finder
24-25	Polyx®-Oil Original – in use
26	Polyx®-Oil Original
28	Polyx®-Oil Rapid
28	Polyx®-Oil Anti-Slip
29	Polyx®-Oil Express
29	Hardener for Polyx®-Oil Express
30	Tannin Spot Remover
31	Wood Wax Finish Clear Extra Thin
31	Concrete Oil
32-33	Wood Wax Finish
34	Spray-Wax
35	Pore Filler Aqua
36-37	2K Wood Oil – in use
38	2K Wood Oil
39	Hardener for 2K Wood Oil
40	Oil Stain
41	Hardener for Oil Stain
42-43	TopOil – in use
44	TopOil
44	Door-Oil
45	Wood Protector
46	Uviwax® UV-Protection
47	Maintenance Oil
48	Liquid Wax Cleaner
48	Liquid Wax Refresher
49	Wash and Care
49	Intensive Cleaner
50	Spray Cleaner
50	Polyx®-Oil Care and Repair Paste
51	Wood Filler
51	Wood Putty
52	Paint Stripper
52	Maintenance Kit for Floors
53	Maintenance Kit for Stairs
53	Osmo TopOil Surface Kit

Exterior

56-57	Product finder	
58-59	Decking-Oil – in use	
60	Decking-Oil	
60	Anti-Slip Decking Oil	
61	Stone and Terracotta Oil	
61	End Grain Sealing Wax	
62	Natural Oil Woodstain	
63	Natural Oil Woodstain Effect	
64-65	Greying Stain – in use	
66	Greying Stain	NEW
67	UV-Protection-Oil	
67	UV-Protection-Oil Extra	
68	One Coat Only HS ^{Plus}	
68	Garden Furniture Oil	
69	Opaque Gloss Wood Stain	
70-71	Garden Stain – in use	
72	Garden Stain	NEW
74-75	Country Shades – in use	
76	Country Shades	
78	Country Colour	
79	WR Base Coat	
80-81	Garden Colour – in use	
82	Garden Colour	
82	Primer	
83	Polymer Composite Maintenance Oil	
83	WPC & Aluminium Cleaner	
84	Wood Reviver Power-Gel	
84	Paint Remover Gel	
85	Decking Cleaner	
85	Garden Furniture Maintenance Kit	

Tools

88-89	Tools with a system	93	Decking and Flooring Cleaning machine
90	System Telescopic Handle	93	Flat Brush
90	Floor Brush	93	Hand Pad Holder
90	Floor Roller Set	93	Oil Finish Application Set
90	Pad Holder with joint	94	Double Blade Scraper
91	Cleaning Kit for Floors	94	Easy Pads
91	Roller and Brush Set	94	Brush Cleaner and Thinner
91	Decking Cleaning Brush with handle	94	Stirring Stick
91	Decking Brush with handle	95	Questions and answers
91	Decking Brush Set		
92	HandXcenter		
92	FloorXcenter		

How our quality standards start your rockets

Get off to a flying start with maximum efficiency and reliability!

High coverage due to a high content of solids

High quality due to raw material tests during procurement

Excellent workability due to our in-house developed binding agents

Development of individual colours – more possibilities for end users

High brand awareness among end consumers

A coating system is a highly complex interplay of various ingredients. A change to one of the components can have effects on all others. For this reason, we follow a groundbreaking quality policy. We develop our own binding agents in in-house research and development laboratories, and we carry out strict tests on raw materials as a part of the procurement process.

These high demands on quality allow us to improve our systems continuously in terms of product coverage, workability, viscosity, open or drying times. As a company certified as per DIN EN ISO 9001 and ISO 14001, we assure our customers maximum efficiency and reliability.

A network of strong partners

We count on a worldwide network of strong trade partners who guarantee excellent product consultation. Osmo complements these activities with project-oriented expert service and hands-on product training.



Project-oriented expert service

The experts from Osmo work hand-in-hand with you on the implementation of specialised projects.



On-target product consultation

Which product for which application? With the help of our product finders on pages 22–23 and 56–57, find the right coating system.



Available worldwide

Thanks to our numerous partners, our products are available around the world.

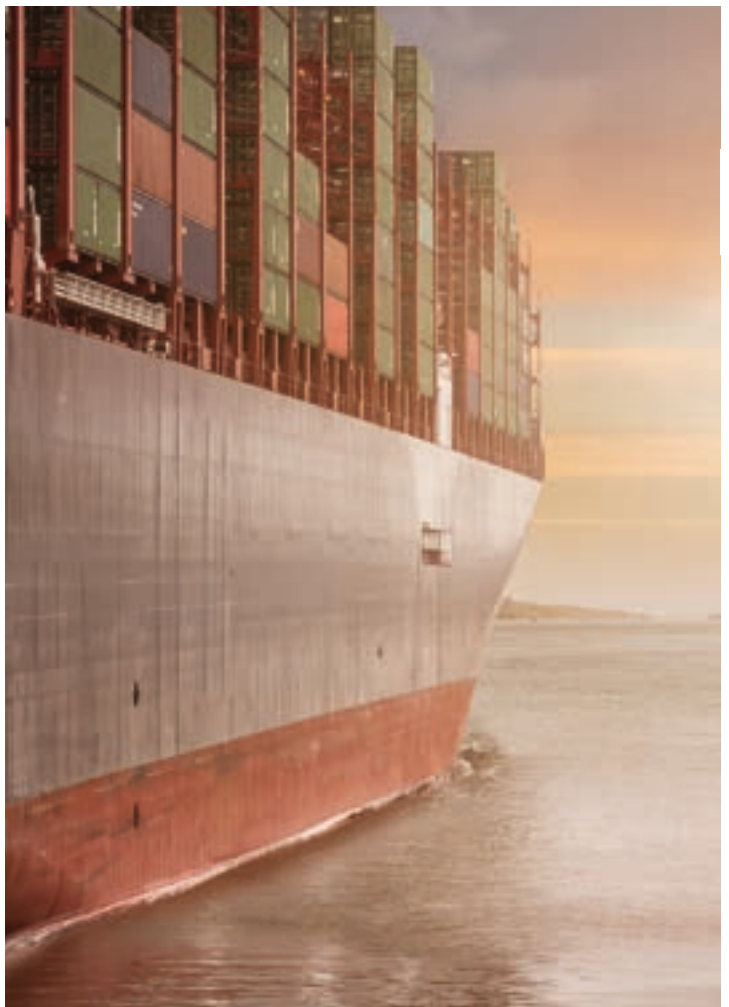



As wood specialists with over 140 years of experience, we have the expertise to develop coating systems formulated optimally for wood.

Wood meets colour

For every wood species and for every application, exactly the right system

There are countless wood varieties, and the requirements placed on coating systems are just as diverse. No matter what the application is, our products impress with optimal protection and long-lasting durability.

Whichever wood species you choose, we have the required experience – for example, in these wood species:

Conifers



Douglas Fir
Spruce
Pine
Larch
Fir
Western Red Cedar
Thermowood Pine
Ponderosa Pine

Broadleaves



Maple
Birch
Beech
Oak
Cherry
Robinia / Locust
Elm
Ash

Exotic



Bangkirai
Bongossi
Cumaru
Ipe
Teak
Tali
Garapa
Massaranduba



Protection according to the parameters

There are different influences to be accounted for: UV radiation, weather conditions, amount of use, slip resistance and much more. No matter what the parameters are, we offer the product suited to your purposes.

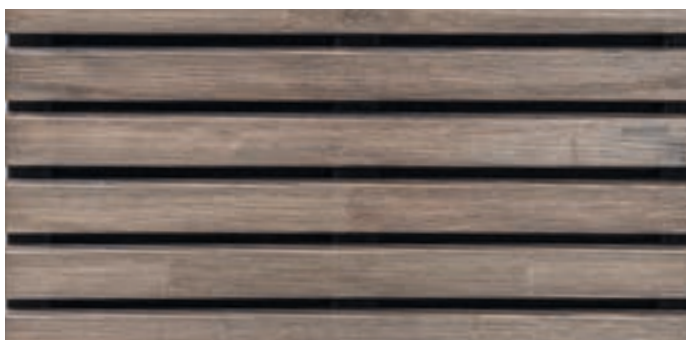

Proven long durability

We constantly perform stress tests on our products to check their durability. We have it black on white: our products last an especially long time.

Henderson Waves Bridge, Singapore

Built in 2008 this fascinating bridge in the heart of Singapore offers walkers and joggers alike a one-of-a-kind urban experience. The planking is

made from Balau wood, a hardwood that is solely present in South-East Asia.

Practical knowledge about wood processing, care and renovation

Values to preserve – this is the aim of professional wood protection. The protection effectiveness of coating systems depends on many factors, for example the wood species or the weathering influences. On the following pages, we offer an overview of what should be observed.







Coating systems for all situations – wood protection facts for practical use

Wood protection, which should last long, must be adjusted precisely to the intended purpose. Therefore, before choosing products, the following parameters are to be observed.



Swelling and shrinkage



Wood swells and shrinks as it absorbs and releases moisture. Our microporous coatings allow this moisture exchange and withstand swelling and shrinkage without blistering, flaking or peeling.



Moisture / waterlogging



Is your outdoor timber frequently exposed to moisture and waterlogging? For this reason, we have a wide range of water-repellent coatings available to you.



Blue stain / fungal and algae attack



Micro-organisms create dark spots and in the long term, they destroy the wood substance. Osmo products with the label "protection against blue stain and rot" help to prevent these attacks.

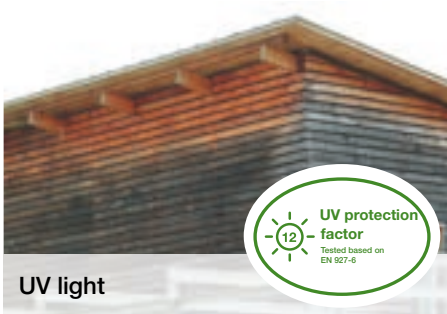

UV light



UV radiation changes the lignin in wood and makes it water-soluble. Rain then washes the lignin away, so wood becomes grey and brittle. Our wood coatings offer an especially high content of solids, and thanks to this, they exhibit very good UV protection.



Health and safety



For interior rooms, we offer a variety of products for a healthy living environment. Look out for products with the features "food safe" and "safe for humans, animals and plants".



Colour



Users enjoy the unlimited choice of colours available from us. Osmo Natural Oil Woodstain, Country Shades, Spray-Wax, Wood Wax Finish, Oil Stain, Decking-Oil and One Coat Only can be ordered in a variety of RAL and NCS colours, which can all be mixed with each other as well. Add colour to your life!

The three forms of wood protection

For wood protection, keep the following rule of thumb in mind: constructional wood protection over physical and chemical wood protection.



Constructional wood protection

In outdoor areas, it is necessary to install wood so it stays as dry as possible or so it can dry off quickly. For these reasons, air should always be able to circulate behind timber cladding to prevent consistent dampness, for example caused by dew. Flooring in indoor areas has constructional wood protection, for example, by means of dirt-catching rugs and felt pads under furniture.



Physical wood protection

Examples of physical wood protection are our products with a high solids content like Osmo Country Colour, Country Shades and Garden Colour, which ensure effective protection against UV radiation.



Chemical wood protection

When all the possibilities of constructional and physical wood protection have been utilised, biocidal active ingredients can be used in outdoor areas. For example, Osmo WR Base Coat helps to prevent rot, blue stain and insect attack. Please use biocides carefully. Before use, always read the label and product information.

Sanding sequences

for oiled surfaces

Well-prepared for perfect results. Perfect sanding is an absolute must for a clean and attractive surface finish. Generally speaking, just like lacquering, before applying Polyx®-Oil, Wood Wax Finish or Oil Stain, wooden flooring has to be sanded with a fine grit. The graphics show our recommended sanding sequences.

The deeper the sanding marks are, the more noticeable the indentations and irregularities will appear. This effect is even more visible with colour treatments as the pigments collect in the sanding marks. It should be decided on site once the last sanding step is completed whether the sanding quality is sufficient for the planned surface treatment.

Depending on the wood species and the applied product, we recommend grit 120 for clear surfaces and grit 120 to 150 for coloured surfaces. Contaminants such as greases, oils or cleaning agents must be carefully removed as they can influence the bond between the wood surface and coating.

12

Important

To keep the transition area between the edge and the remaining field area from being noticeable, the following sanding step sequence must be maintained:

For the field sanding with a drum or belt sanding machine and for the subsequent sanding step with the edge sanding machine, always use the same grit:

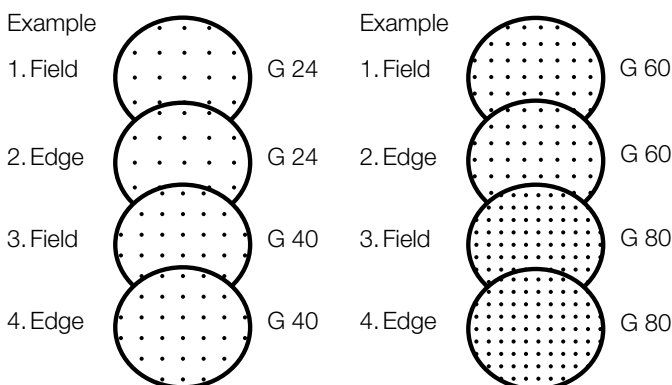

For field sanding with a single disc or three-disc sanding machine, always use the same grit as in the previous sanding steps with the edge sanding machine.

Sanding wooden flooring with a single or multi-disc sanding machine

New Installation /
Renovation

New Installation
with minimal
over/under wood

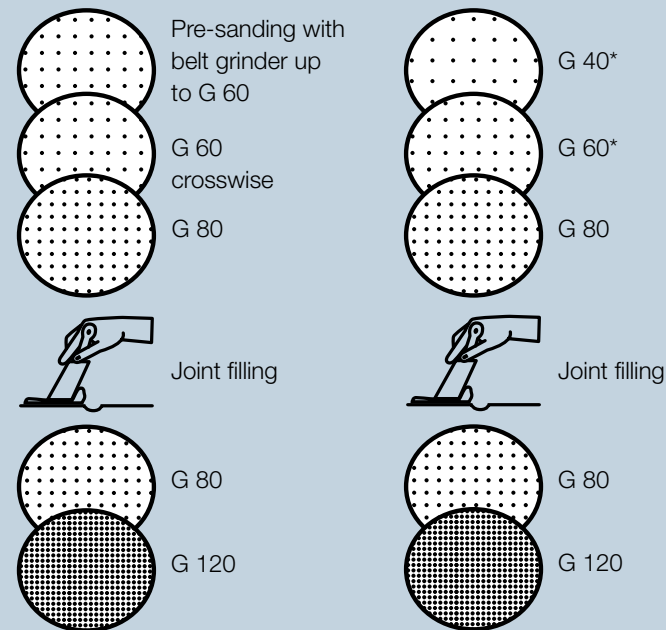

Important

- > For an ideal surface, a sanding screen must be used for the final sanding step. The grit of the sanding screen must be the same as the grit used for the sanding discs in the previous step.
- > Directly before starting each work step, thoroughly vacuum the floor and expansion gap.

*Depending on the condition of the wooden flooring, start with one of these grits.

Sanding wooden flooring with a belt or drum sanding machine

New Installation

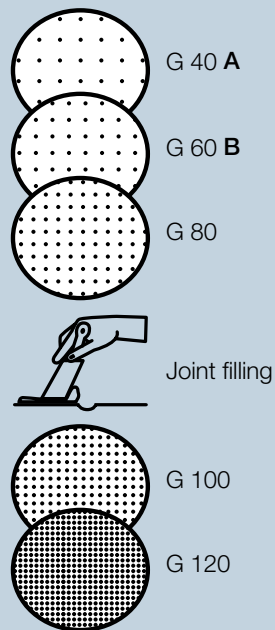

Renovation

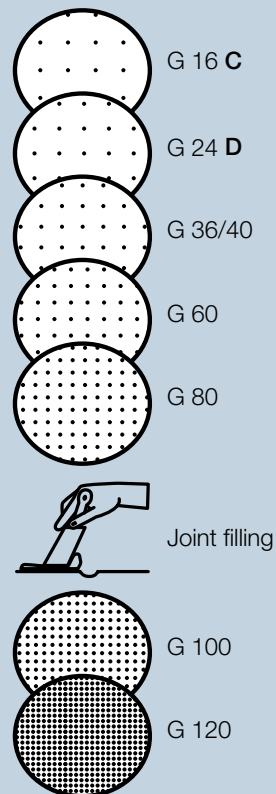

Check surface quality and perform additional sanding steps depending on the result.

Change to a single disc machine for the final sanding step.

Sanding wooden flooring with an edge sanding machine

New Installation

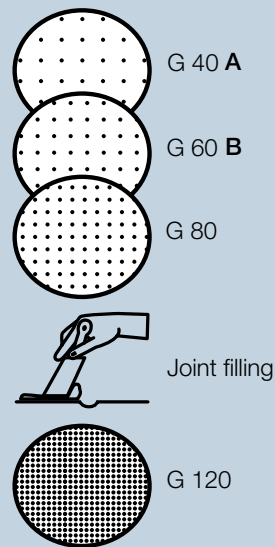

Renovation

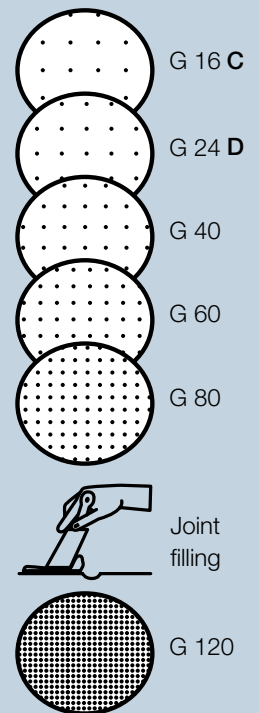

- A** Large differences in height between the individual wooden elements.
- B** Small differences in height between the individual wooden elements.
- C** Thick finish layer, large amount of dirt and stains or deep scratches.
- D** Thin finish layer, normal amount of dirt and stains or scratches.



All-round protection

Maintenance and care for wooden flooring in indoor areas

The rule for wooden flooring: long-lasting durability depends significantly on the right care. Here is how to provide flooring all-round protection.

Floor cleaning

Dust and lint are removed quickly and easily with the green Dust-Mop in Osmo Cleaning Kit for Floors. Also included in the Kit are a mop for damp cleaning and an Active Fibre Cloth for refreshing floors with Osmo Liquid Wax Cleaner.

For damp mopping, the white Micro-Mop is recommended. A dash of Osmo Wash and Care in mop water removes dirt and grime, and thanks to natural oils, it prevents the flooring from drying out.

Remember:

Avoid using aggressive all-purpose cleaners. Only use a slightly damp mop – not wet! If necessary, wipe dry.





Repairing small surface damages

On flooring treated with Osmo Polyx®-Oil, first tape off the damaged area with masking tape, then sand and thoroughly remove any sanding dust.

For clear coated flooring: evenly apply a thin coat of clear Polyx®-Oil with Osmo Microfibre Roller, ventilate well and leave to dry for approx. 8-10 hours. Afterwards thinly apply another coat of clear Polyx®-Oil with a lint-free cotton cloth. The sheen can be adjusted by polishing the surface with Osmo Liquid Wax Cleaner.

For colour coated flooring: apply a thin coat of Osmo Oil Stain or a coloured Polyx®-Oil Original, or a mixture of Wood Wax Finish and Polyx®-Oil Original. The mixing ratio must be the same as the original coating. Leave to dry for 24 hours. If the colour results are not suitable, repeat the process. Afterwards apply a thin coat of clear Polyx®-Oil with a lint-free cotton cloth.

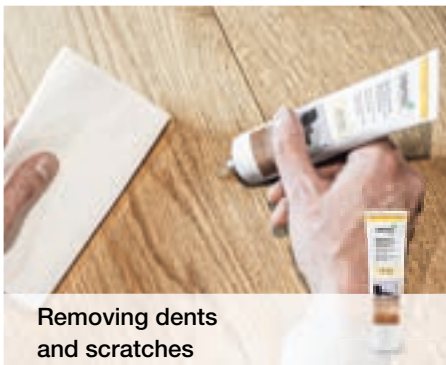

Removing dents and scratches



Intensive cleaning and refreshing



Restoration and re-oiling

On surfaces treated with Osmo Polyx®-Oil, smaller damages and scratches are very easy to repair. For such cases, Osmo offers Polyx®-Oil Care and Repair Paste. After cleaning and removing any dust from the surface, the product is simply applied to the damaged area and rubbed in, for example, with Osmo Easy Pads. After 8-10 hours, the surface is dry. Repeat the process 2-3 times as needed.

From time to time, wooden flooring needs refreshing. This retains the beautiful appearance and ensures surface protection. For this, Osmo Liquid Wax Cleaner refreshes wooden flooring optimally. Treatment is carried out with the help of an Active Fibre Cloth found in Osmo Cleaning Kit for Floors. For professionals, we recommend for larger areas our floor cleaning machine Osmo FloorXcenter and for smaller areas Osmo HandXcenter.

On oiled wooden flooring, the protective surface can be renewed at any time without sanding off the existing coating. Clean the floor thoroughly and apply a very thin coat of clear Osmo Polyx®-Oil with Osmo Flooring Brush or Osmo Microfibre Roller. For professionals, we recommend our Osmo FloorXcenter or HandXcenter as ideal tool for machine applications.

**Our tip:
further information
about cleaning and care**



Sustainably weatherproof

Maintenance and care for timber decking and cladding in outdoor areas

There are countless influences that affect exterior decking and cladding made of wood; our maintenance and care products for such surfaces are just as diverse.



Initial care

After the decking has been properly installed and has weathered for a suitable amount of time, the surface can be treated. If the original wood colour is to be preserved for a long time, treat decking with two coats of a pigmented Osmo Decking-Oil

in a suitable colour for the wood species. The coats should be thin, even and applied with the wood grain in dry weather. However, if you decide to let a natural patina develop on your decking, treat it with clear Osmo Decking-Oil Teak.

16

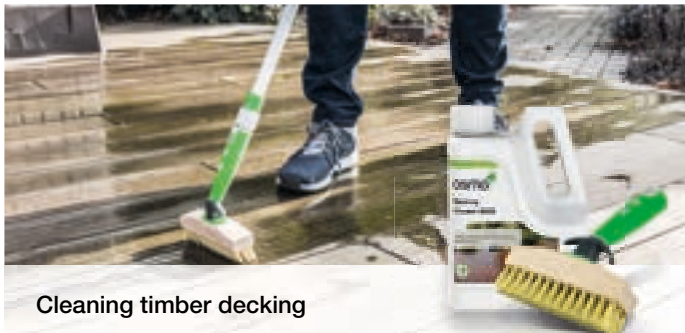

Cleaning timber decking

Remove any dirt and tough stains with water and Osmo Decking Cleaner. Mixing ratios vary between 1:1 and 1:25 depending on the contamination. Clean timber decking with Osmo Decking Cleaning Brush or a scrub brush, the whole time working with the wood grain. Afterwards rinse the surface with clear water. For professionals, we recommended cleaning larger areas with Osmo Decking and Flooring Cleaning Machine.

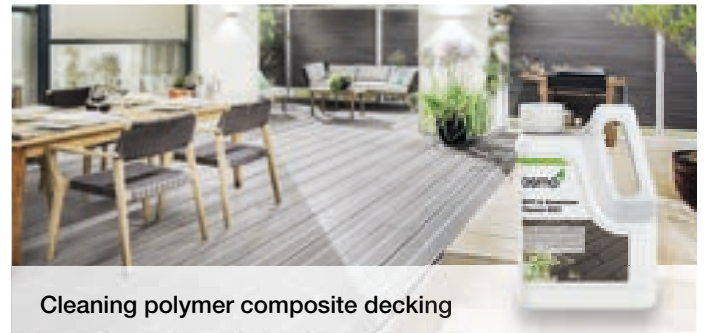

Cleaning polymer composite decking

WPC and BPC decking can discolour, for example through so-called “water rings”, which may appear due to a reaction between moisture and the low wood content. This – along with other discolorations – can be easily removed with Osmo WPC & Aluminium Cleaner 8021. To perform this task, first remove dust and loose dirt with a firm broom or a hand broom. The concentrate can be diluted with water as needed in a mixing ratio from 1:10 to 1:20. Then apply the cleaning solution with Osmo Decking Cleaning Brush to the whole area and allow it to react for 10 minutes. Afterwards rinse thoroughly with water. For professionals, as an ideal tool for machine applications, we recommend our Osmo Decking and Flooring Cleaning Machine. After thoroughly drying, a thin coat of Osmo Polymer Composite Maintenance Oil can be applied. The coating makes the surface water-repellent as well as dirt and stain-resistant.



**Our tip:
Information about
cleaning and care**



Intensive cleaning and refreshing

If your timber cladding has developed a natural grey patina, then specialised cleaning and refreshing is the answer. To do this, the entire cladding is dampened with clear water. Afterwards, apply Osmo Wood Reviver Power-Gel generously with a brush, always working with the wood grain. After 20 minutes' reaction time, the surface is cleaned with a stiff brush and rinsed with plenty of water. Osmo Wood Reviver Power-Gel helps in three ways. In one work step, the gel cleans the surface, loosens old peeling surface finishes and removes greying.

After drying for 48 hours, the refreshed wood surface should now be treated with an Osmo Natural Oil Woodstain. This coating is a base coat and top coat in one, so it offers long-lasting optimal protection.

For timber decking, after the treatment with Osmo Wood Reviver Power-Gel and the appropriate drying time, the refreshed wood surface should be maintained and protected with a coat of Osmo Decking-Oil.



Simple cleaning for large areas

For larger deck areas, Osmo Decking and Flooring Cleaning Machine facilitates the cleaning. This machine loosens dirt and grime, and removes it in one work step. Its abrasive brushes rotate in opposite directions so that the dirt is drawn into the intended container. A freshwater tank ensures the surface stays damp while cleaning. For tough dirt and stains or greyed wood surfaces, the cleaning procedure can be repeated with the machine.





colour & protection | interior

Osmo recommends

Recommendations for Wood Species

WOOD SPECIES	POLYX®-OIL ORIGINAL	POLYX®-OIL RAPID	POLYX®-OIL EXPRESS	POLYX®-OIL EX-PRESS + HARDENER FOR POLYX®-OIL EXPRESS	POLYX®-OIL ANTI-SLIP	WOOD WAX FINISH CLEAR EXTRA THIN	POLYX®-OIL TINTS
Maple	+	+	+	+	+	o	+
Afromosia	-	-	-	+ ¹⁾	-	+	-
Acacia / Wattle	+ ¹⁾	+ ¹⁾	+ ¹⁾	+ ¹⁾	+ ¹⁾	o	+ ¹⁾
Bamboo	+ ¹⁾	+ ¹⁾	+ ¹⁾	+ ¹⁾	+ ¹⁾	o	-
Birch	+	+	+	+	+	o	+
Pear	+	+	+	+	+	o	+
Beech	+	+	+	+	+	o	+
Doussie / Afzelia	-	-	-	+ ¹⁾	-	+	-
Oak	+	+	+	+	+	o	+
Oak, smoked	+ ¹⁾	+ ¹⁾	+ ¹⁾	+ ¹⁾	+ ¹⁾	o	+ ¹⁾
Alder	+	+	+	+	+	o	+
Ash	+	+	+	+	+	o	+
Eucalyptus	+ ¹⁾	+ ¹⁾	+ ¹⁾	+ ¹⁾	+ ¹⁾	o	+ ¹⁾
Spruce / Pine	+	+	+	+	+	o	+
Ipe	-	-	-	+ ¹⁾	-	+	-
Jarraah, Australian	+	+	+	+	+	o	+
Jatoba	+ ¹⁾	+ ¹⁾	+ ¹⁾	+ ¹⁾	+ ¹⁾	+	-
Kambala / Iroko	-	-	-	+ ¹⁾	-	+	-
Kempas	+ ¹⁾	+ ¹⁾	+ ¹⁾	+ ¹⁾	+ ¹⁾	o	+ ¹⁾
Pine	+	+	+	+	+	o	+
Cherry	+ ¹⁾	+ ¹⁾	+ ¹⁾	+ ¹⁾	+ ¹⁾	o	+ ¹⁾
Cork	+ ¹⁾	+ ¹⁾	+ ¹⁾	+ ¹⁾	+ ¹⁾	o	+ ¹⁾
Larch	+	+	+	+	+	o	+
Mahogany	-	-	-	+ ¹⁾	-	+	-
Merbau	+ ¹⁾	+ ¹⁾	+ ¹⁾	+ ¹⁾	+ ¹⁾	+ ¹⁾	+ ¹⁾
Walnut, American	+ ¹⁾	+ ¹⁾	+ ¹⁾	+ ¹⁾	+ ¹⁾	o	+ ¹⁾
Walnut, Brazilian	-	-	-	+ ¹⁾	-	+	-
Olive	+ ¹⁾	+ ¹⁾	+ ¹⁾	+ ¹⁾	+ ¹⁾	+	+ ¹⁾
OSB, sanded	+ ¹⁾	+ ¹⁾	+ ¹⁾	+ ¹⁾	+ ¹⁾	o	+ ¹⁾
Rosewood	-	-	-	+ ¹⁾	-	+	-
Pitch Pine	+	+	+	+	+	o	+
Robinia / Locust	+	+	+	+	+	o	+
Teak	+ ¹⁾	+ ¹⁾	+ ¹⁾	+ ¹⁾	+ ¹⁾	o	+ ¹⁾
Tigerwood	+ ¹⁾	+ ¹⁾	+ ¹⁾	+ ¹⁾	+ ¹⁾	o	-
Elm	+	+	+	+	+	o	+
Walnut	+ ¹⁾	+ ¹⁾	+ ¹⁾	+ ¹⁾	+ ¹⁾	o	+ ¹⁾
Wenge	-	-	-	+ ¹⁾	-	+	-

WOOD SPECIES

	WOOD WAX FINISH	2K WOOD OIL	OIL STAIN	DOOR-OIL
Maple	o	+	o	+
Afromosia	-	+	-	-
Acacia / Wattle	+ ¹⁾	+	+	+ ¹⁾
Bamboo	-	+	-	+ ¹⁾
Birch	+	+	+	+
Pear	+	+	+	+
Beech	o	+	+	+
Doussie / Afzelia	-	+	-	-
Oak	+	+	+	+
Oak, smoked	+ ¹⁾	+	+	+ ¹⁾
Alder	+	+	+	+
Ash	+	+	+	+
Eucalyptus	o	+	o	+ ¹⁾
Spruce / Pine	+	+	+	+
Ipe	-	+	-	-
Jarraah, Australian	+	+	+	+
Jatoba	-	+	-	+ ¹⁾
Kambala / Iroko	-	+	-	-
Kempas	o	+	o	+ ¹⁾
Pine	+	+	+	+
Cherry	-	+	-	+ ¹⁾
Cork	+ ¹⁾	+	+	-
Larch	+	+	+	+
Mahogany	-	+	-	-
Merbau	o	+	o	+ ¹⁾
Walnut, American	o	+	o	+ ¹⁾
Walnut, Brazilian	-	+	-	-
Olive	-	+	-	+ ¹⁾
OSB, sanded	+ ¹⁾	+	+	+ ¹⁾
Rosewood	-	+	-	-
Pitch Pine	+	+	+	+
Robinia / Locust	+	+	+	+
Teak	+ ¹⁾	+	+	+ ¹⁾
Tigerwood	-	+	-	+ ¹⁾
Elm	+	+	+	+
Walnut	o	+	+	+ ¹⁾
Wenge	-	+	-	-

+ Recommended
 +¹⁾ Thin application!
 o Possible
 - Not recommended

Product finder

Polyx®-Oil Original Polyx®-Oil Rapid Polyx®-Oil Anti-Slip Polyx®-Oil Express Tannin Spot Remover Wood Wax Finish Clear Extra Thin Concrete Oil Wood Wax Finish Transparent Colours



Page	26	28	28	29	30	31	31	32
Floor	●	●	●	●	●	●	●	●
Furniture	●	●	-	●	●	●	●	●
Wall/Ceiling	-	-	-	-	-	●	●	●
Work surfaces	●	●	-	●	●	-	●	●
Doors	-	-	-	-	-	-	-	●
Stairs	●	●	●	●	●	●	●	●
Children's toys	●	●	-	●	-	●	-	●
Wet room	●	●	●	●	-	-	●	●
Windows	-	-	-	-	-	-	-	●

22

Uviwax® UV-Protection Maintenance Oil Liquid Wax Cleaner Liquid Wax Refresher Wash and Care Intensive Cleaner Spray Cleaner Polyx®-Oil Care and Repair Paste



Page	46	47	48	48	49	49	50	50
Floor	-	●	●	●	●	●	●	●
Furniture	-	●	●	●	●	●	●	●
Wall/Ceiling	●	●	●	-	●	●	●	●
Work surfaces	-	●	●	●	●	●	●	●
Doors	●	●	●	-	●	●	●	●
Stairs	-	●	●	●	●	●	●	●
Children's toys	●	●	●	-	●	●	●	●
Wet room	-	●	●	-	●	●	●	●
Windows	-	●	●	-	●	●	●	●

● Suitable for

● Specialist knowledge and tools required

Wood Wax Finish Intense Colours Spray-Wax Pore Filler Aqua 2K Wood Oil Oil Stain TopOil Door-Oil Wood Protector

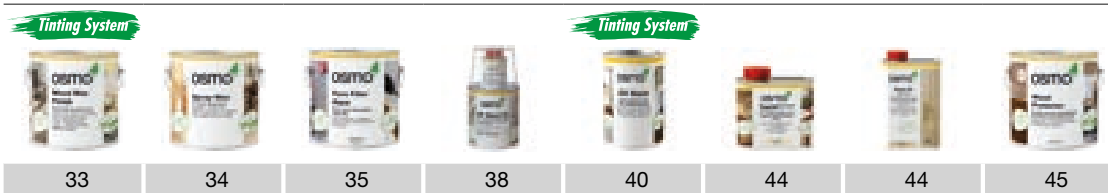

33	34	35	38	40	44	44	45
●	●	●	●	●	-	-	-
●	●	●	●	●	●	-	●
●	-	-	-	-	-	-	●
●	●	●	-	●	●	-	-
●	●	-	-	-	-	●	-
●	●	●	●	●	-	-	-
●	●	●	-	●	●	-	●
●	●	●	-	●	-	-	●
●	-	-	-	-	-	-	●

Wood Filler Wood Putty Paint Stripper Maintenance Kit for Floors Osmo Maintenance Kit for Stairs Osmo TopOil Surface Kit

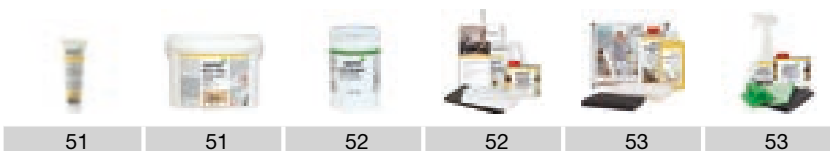

51	51	52	52	53	53
●	●	-	●	-	-
●	-	●	-	-	●
●	-	-	-	-	-
●	-	●	-	-	●
●	-	●	-	-	-
●	●	●	●	●	-
●	-	●	-	-	●
●	-	●	●	-	-
●	-	●	-	-	-

- Microfiber Roller
- Flat Brush
- Flooring/Decking brush
- Mop
- Cloth
- Trowel
- Pad
- FloorXcenter
- Spray gun
- HandXcenter

Note: Product coverage varies significantly depending on the condition of the existing wood. All information refers to smooth and planed/cut surfaces. Other surfaces, e.g. grooved or ribbed, may lead to deviations in product coverage. Targeted results may vary depending on the wood species and surface properties; therefore, a trial application is recommended.

Gardermoen Airport, Norway

On over 24,000 square metres of flooring, Osmo Polyx®-Oil finds its purpose, in particular on the high traffic areas in restaurants and duty-free

shops. A successful practical and endurance test: annually the airport serves around 30 million passengers.

A protection shield against the toughest conditions

Polyx®-Oil Original combines effective wear protection with optimal indoor climate.

Polyx®-Oil Original



Ideal for high traffic surfaces

Special advantages

- > Effective protection against dirt, stains and wear
- > For high traffic areas in commercial interiors
- > Free of toxic biocides, preservatives, aromatic compounds and allergy-causing turpentine oils
- > Wide product range, when needed with extremely short drying times for professionals
- > Spot-repairable



Polyx®-Oil Original



	Based on renewable raw materials		Microporous and breathable surface		Resistant to wine, beer, cola
	Recoatable: Clear: approx. 8-10 h Coloured: approx. 24 h		24 m ² /l roller 30 m ² /l brush 1 coat		Spot applications possible
	Wood grain remains noticeable		Scratch-resistant and hard-wearing		

Osmo Polyx®-Oil Original is ideal for the protection of all wooden floors, such as solid wood, plank, strip, OSB and cork flooring, as well as furniture surfaces.

Methods of Application

Finished surface in 2 days, 2 coats

1. First coat on the raw, sanded wood approx. 30-40 ml/m².
2. Mistakes in the wet coating can be corrected up to 30 minutes after the first application.
3. Drying time approx. 8-10 hours (clear) or approx. 24 hours (coloured) (normal climatic conditions, 23°C/50 % rel. humidity). Lower temperatures and/or higher humidity can increase drying time. Allow for good ventilation.
4. If desired, the dried finish can be smoothed with fine grain sandpaper (P400).
5. Top coat approx. 30-40 ml/m² with a clear Polyx®-Oil (except for 3040 and 3044).
6. For drying times, see point 3.

For floors with a white base coat, a top coat with either Osmo Polyx®-Oil Original 3040 White or 3044 Raw is recommended.

Colour code	Can size Litre	Article Number	Unit/pack
3011 Clear Glossy	0.375	103 00 161	4
	0.75	103 00 162	4
	2.50	103 00 163	2
	10.00	103 00 164	1
	25.00	103 00 165	1
3032 Clear Satin	0.375	103 00 023	4
	0.75	103 00 001	4
	2.50	103 00 002	2
	10.00	103 00 003	1
	25.00	103 00 004	1
3062 Clear Matt	0.375	103 00 043	4
	0.75	103 00 045	4
	2.50	103 00 050	2
	10.00	103 00 055	1
	25.00	103 00 057	1
3065 Clear Semi-matt	0.375	111 00 118	4
	0.75	111 00 119	4
	2.50	111 00 120	2
	10.00	111 00 121	1
	25.00	111 00 109	1

Colour code	Can size Litre	Article Number	Unit/pack
3040 White Satin	0.75	103 00 021	4
	2.50	103 00 022	2
	10.00	103 00 034	1
3044 Raw Matt	0.75	103 00 113	4
	2.50	103 00 114	2
3067 Light Grey Satin	0.75	103 00 406	4
	2.50	103 00 408	2
	10.00	103 00 411	1
3071 Honey Satin	0.75	101 00 294	4
	2.50	101 00 300	2
	10.00	103 00 135	1
3072 Amber Satin	0.75	101 00 302	4
	2.50	101 00 303	2
	10.00	103 00 205	1
3073 Terra Satin	0.75	101 00 305	4
	2.50	101 00 306	2
	10.00	103 00 235	1
3074 Graphite Satin	0.75	101 00 311	4
	2.50	101 00 312	2
	10.00	103 00 285	1
3075 Black Satin	0.75	101 00 317	4
	2.50	101 00 318	2
	10.00	103 00 295	1

26

TIP

Bring colour in your life! Coloured flooring.

Coloured flooring is really in style, and an end to this trend is not in sight. Our tips for you to make a big hit with your customers:

1. Staining floors with Polyx®-Oil

Apply a coloured Polyx®-Oil Original variation as the first coat – a product that comes in eight different colours. Afterwards a coat of with a clear Polyx®-Oil is carried out.

2. Staining floors with Wood Wax Finish

Normal staining

First apply one coat with Wood Wax Finish and top coat with a clear Osmo Polyx®-Oil.

Subtle staining

Mix Wood Wax Finish and Polyx®-Oil Original in a mixing ratio of 1:10, and apply the first coat with the mixture. The second coat is carried out with a clear Osmo Polyx®-Oil.

Please note

Intense colour applications with Wood Wax Finish are not possible on flooring. A second coat is not recommended.

When staining floors with Wood Wax Finish 3111 White, 3186 White Matt or 3188 Snow, the top coat should be carried out with either Osmo Polyx®-Oil Original 3040 White or 3044 Raw.



Raw Look. Natural beauty.

Wood as a natural raw material should look more and more often as if it were untreated. As plank flooring, wood formed by nature and adorned with natural features, such as knots or grain, gives the home a unique and one-of-a-kind atmosphere.

Wood surfaces treated with **Osmo Polyx®-Oil Original Raw**

retain their natural colour. White pigments prevent the “permanent wet effect”; the wood colour and grain will not be enhanced. The surfaces look like they were left untreated and are still reliably protected!

Polyx®-Oil Rapid



- Based on renewable raw materials
- Microporous and breathable surface
- Resistant to wine, beer, cola
- Easy to clean and maintain
- Recoatible: Clear: approx. 4-5 h; Coloured: approx. 8-10 h
- 30 m²/1 l
- Fast drying
- Scratch-resistant and hard-wearing
- Spot applications possible

Osmo Polyx®-Oil Rapid is ideal for the protection of all wooden floors, such as solid wood, plank, strip, OSB and cork flooring, as well as for furniture surfaces.

Colour code	Can size Litre	Article Number	Unit/pack
3232 Clear Satin	0.75	103 00 093	4
	2.50	103 00 092	2
	10.00	103 00 091	1
	25.00	103 00 085	1
3262 Clear Matt	0.75	103 00 101	4
	2.50	103 00 098	2
	10.00	103 00 097	1
	25.00	103 00 096	1
3240 White Satin	0.75	151 00 512	4
	2.50	151 00 513	2
	10.00	151 00 518	1
	25.00	151 00 519	1

Methods of Application

Finished surface in 1 day, 2 coats

- First coat on the raw, sanded wood approx. 30-40 ml/m².
- Mistakes in the wet coating can be corrected up to 15 minutes after the first application.
- Drying time approx. 4-5 hours (clear) or approx. 8-10 hours (white Transparent) (normal climatic conditions, 20-23 °C/50-65 % rel. humidity). Lower temperatures and/or higher humidity increase drying times significantly. Ventilate well while drying.
- If desired, the dried finish can be smoothed with fine grain sandpaper (P240-360) or with an abrasive pad before applying the second coat.
- Second coat approx. 30-40 ml/m².
- Drying time approx. 5-6 hours; otherwise see point 3.

Polyx®-Oil Anti-Slip



- Non-slip surface through anti-slip additives
- Based on renewable raw materials
- Microporous and breathable surface
- Resistant to wine, beer, cola
- Easy to clean and maintain
- Recoatible after approx. 8-10 hours
- 24 m²/1 l 1 coat
- Ideal for commercial interiors
- Scratch-resistant and hard-wearing

Osmo Polyx®-Oil Anti-Slip is ideal for the protection of all wooden floors and stairs that require higher slip resistance (commercial/public interiors), such as solid wood, plank, strip, OSB and cork flooring.

Colour code	Can size Litre	Article Number	Unit/pack
3088 Clear Semi-matt (R9)	0.75	104 00 077	4
	2.50	104 00 078	2
	10.00	104 00 079	1
3089 Clear Satin (R11)	0.75	104 00 095	4
	2.50	104 00 096	2
	10.00	104 00 097	1
3094 Black Matt (R9)	0.75	101 00 497	4
	2.50	101 00 498	2
	10.00	101 00 499	1

Methods of Application

Finished surface in 2 days, 2 coats

- First coat on the raw, sanded wood approx. 35-45 ml/m².
- Mistakes in the wet coating can be corrected up to 30 minutes after the first application.
- Drying time approx. 8-10 hours (normal climatic conditions, 23 °C/50 % rel. humidity). Lower temperatures and/or higher humidity can increase drying time. Allow for good ventilation.
- Second coat approx. 35-45 ml/m².
- Drying time approx. 8-10 hours; see point 3.

Note: Osmo Polyx®-Oil Anti-Slip cannot be distributed with a single disc machine with white pad.

TIP

Shining results. Changes in sheen.

A completely normal process: over time, satin surfaces become matter, and matt surfaces become glossier. We, therefore, recommend explaining these changes in sheen to your customers in forefront. That way, later on, these changes in sheen will not be seen as defects in quality.

Our tip: if your customers would like to change the sheen, this can be done without any difficulties. Polishing the surface with **Osmo Liquid Wax Cleaner** gives flooring more sheen. A too glossy surface, on the other hand, can be corrected with a coat of **Osmo Maintenance Oil Matt**.

Polyx®-Oil Express

Hardener for Polyx®-Oil Express



	Applications with hardener possible		Based on renewable raw materials		Microporous and breathable surface
	Resistant to wine, beer, cola		Recoatable after approx. 2-3 hours		24 m²/1 l 1 coat
	Easy to clean and maintain		Very fast drying		Scratch-resistant and hard-wearing

	Shortened drying time		Especially suited for oily and resinous woods		Ideal for commercial interiors
--	-----------------------	--	---	--	--------------------------------

Osmo Polyx®-Oil Express is ideal for the protection of all wooden flooring, such as solid wood, plank, strip, OSB and cork flooring, as well as furniture surfaces. In combination with Hardener 6632, also suitable for the clear treatment of hardwoods rich in extractives, such as Meranti, Wengé, Merbau etc.

Osmo Hardener for Polyx®-Oil Express acts as an additive for Osmo Polyx®-Oil Express for accelerated drying.

Colour code	Can size Litre	Article Number	Unit/pack
3332 Clear Satin	0.75	103 00 132	4
	2.50	103 00 134	2
	10.00	103 00 136	1
	25.00	103 00 138	1
3362 Clear Matt	0.75	103 00 282	4
	2.50	103 00 284	2
	10.00	103 00 286	1
	25.00	103 00 288	1
3340 White Transparent	0.75	103 00 293	4
	2.50	103 00 289	2
	10.00	103 00 291	1
	25.00	103 00 292	1

Colour code	Can size Litre	Article Number	Unit/pack
6632 Clear	0.15	151 00 525	6

Methods of Application

Finished surface in 1 day, 2 coats

1. Open the bottle of Hardener and pour contents into a 2.5 L can of Polyx®-Oil Express. Empty bottle completely. Stir thoroughly. Processing to be carried corresponds to that of Polyx®-Oil Express.
2. Drying time approx. 1-2 hours (normal climatic conditions, 23 °C/50 % rel. humidity). Lower temperatures and/or higher humidity can increase drying time. Allow for good ventilation. (1st and 2nd coat)

Note: Pot time is reduced down to 60 minutes by adding Hardener. Please do not mix together more material than you can certainly process within 45 minutes. If you do not use the entire can of Polyx®-Oil Express, add 6 % Hardener – mix in a separate container!

Methods of Application

Finished surface in 1 day, 2 coats

1. First coat on the raw, sanded wood approx. 35-45 ml/m².
2. Mistakes in the wet coating can be corrected up to 5 minutes after the first application.
3. Drying time approx. 2-3 hours (clear) or approx. 6-8 hours (White transparent) (normal climatic conditions, 23 °C/50 % rel. humidity). Lower temperatures and/or higher humidity increase drying times significantly. Ventilate well while drying.
4. If desired, the dried finish can be smoothed with fine grain sandpaper (P240-360) or with a scouring pad before applying the second coat.
5. Second coat approx. 35-45 ml/m².
6. Drying time approx. 4-5 hours; otherwise see point 3.

Note: Can be used optionally with Hardener for Polyx®-Oil Express 6632 as drying accelerator.

Tannin Spot Remover



10 m²/1 l
1 application



Simple application



Ready to use



For interior and exterior



Versatile in use

Methods of Application

Finished surface in 1 day

1. Spray Osmo Tannin Spot Remover evenly onto the spot until the surface is completely covered.
2. Allow product to react for 30-45 minutes and wipe with a lint-free cloth.
3. If necessary, repeat and then wipe clean with clear water.
4. After drying, apply a suitable Maintenance Oil on the treated area, so that the wood is protected again.

Osmo Tannin Spot Remover is especially recommended for wooden flooring (e.g. parquet), work surfaces or garden decking and furniture made of Oak.

Colour code	Can size Litre	Article Number	Unit/pack
6602 Clear	0.25	139 00 149	6

30

TIP



Water spot and discolourations on wood? No problem!

Untreated wood is sensitive. Unattractive water spots and dark discolorations quickly appear on wood because various substances, such as iron, acids or bases respond to the tannin acid. Remove these spots fast and effectively with **Tannin Spot Remover** – spray onto the surface, leave it to be absorbed and done. Use carefully on smoked wood as the treatment may bleach the wood colour.

Wood Wax Finish Clear Extra Thin

Concrete Oil



- Based on renewable raw materials
- Microporous and breathable surface
- Resistant to wine, beer, cola
- Easy to clean and maintain
- Recoat after approx. 12 hours
- 24 m²/l | 1 coat
- Especially suited for oily and resinous woods
- Deeply penetrating
- Spot applications possible

Osmo Wood Wax Finish Clear Extra Thin is suitable for the protection of wood in indoor areas: wall and ceiling panelling, wooden flooring, furniture and toys. Osmo Wood Wax Finish Clear Extra Thin is also particularly suited to the clear treatment of hardwoods rich in extractives, such as Meranti, Wengé, Merbau etc.

Colour code	Can size Litre	Article Number	Unit/pack
1101 Clear Satin	0.75	102 00 001	4
	2.50	102 00 002	2
	25.00	102 00 003	1

Methods of Application

Finished surface in 2 days, 2 coats

1. First coat on the raw, sanded wood approx. 35-45 ml/m².
2. Leave to absorb for 30 minutes. Wipe away all excess wax and touch up untreated areas.
3. Drying time approx. 12 hours (normal climatic conditions, 23 °C/50 % rel. humidity). Lower temperatures and/or higher humidity can increase drying time. Allow for good ventilation.
4. Second coat approx. 35-45 ml/m².
5. Leave to absorb for 30 minutes and wipe away any excess wax.
6. Drying time approx. 12 hours; see point 3.



- Based on renewable raw materials
- Microporous and breathable surface
- Water and dirt repellent surface
- Easy to clean and maintain
- Recoat after approx. 8-10 hours
- 50 m²/l | 1 coat

Osmo Concrete Oil is suitable for the clear impregnation of nearly all types of concrete (exposed concrete), artificial stone, screed as well as microporous natural stone with a polished, sanded or break surface as well as for unglazed tiles. Especially suited as wall panelling and flooring in the kitchen and bath as well as for tabletops, windowsills and kitchen worktops.

Colour code	Can size Litre	Article Number	Unit/pack
610 Clear Satin	0.75	115 00 115	4
	2.50	115 00 116	2







Methods of Application

Finished surface in 2 days, 2 coats

1. With an Osmo Flat Brush, Floor Brush, Coating Applicator Fleece or Microfibre Roller apply very thinly and spread well.
2. Remove excess with a pad or lint-free cloth
3. Drying time approx. 8-10 hours (normal climatic conditions, 23 °C / 50 % rel. humidity). Lower temperatures and/or higher air humidity can increase the drying time. Ventilate well while drying.
4. Apply the second coat also very thin. Remove any excess with a pad or a lint-free cloth. (When renovating already oiled surfaces, normally one coat on a cleaned surface is sufficient.)
5. Drying time approx. 8-10 hours; see point 3.

Wood Wax Finish Transparent Colours



	Based on renewable raw materials		Microporous and breathable surface		Resistant to wine, beer, cola
	Easy to clean and maintain		Recoat after approx. 24 hours		24 m ² /1 l 1 coat
	Simple application				

Osmo Wood Wax Finish is suitable for the protection and the decorative finishing of wood in indoor areas: wall panelling, mouldings and beams as well as doors. It is also suitable for edge-glued panels, chipboard and MDF. Ideal as a coloured base coat for wooden flooring and for recoating darkened wood surfaces. Highly recommended for furniture and children's toys.

Methods of Application

Finished surface in 1-2 days, 1-2 coats

1. First coat on the raw, sanded wood approx. 35-45 ml/m².
2. Mistakes in the wet coating can be corrected up to 30 minutes after the first application.
3. Drying time approx. 12 hours (normal climatic conditions, 23 °C/50 % rel. humidity). Lower temperatures and/or higher humidity can increase drying time. Allow for good ventilation.

For a lightly stained effect: within 20 minutes after the application, wipe with a cloth or with a white pad along the wood grain.

Intense: If a more intense colour effect is desired, repeat the application (apply maximum two coats). This only applies to intense colour shades.

As a coloured base coat for flooring: drying time approx. 24 hours (instead of 12 hours; see point 3). Second coat approx. 35-45 ml/m² with a clear Polyx®-Oil. Drying time approx. 8-10 hours; see point 3.

For floors with a white base coat, a top coat with either Osmo Polyx®-Oil Original 3040 White is recommended.

32

Colour code	Can size Litre	Article Number	Unit/pack
3101 Clear Transparent	0.125	101 00 091	6
	0.375	101 00 001	4
	0.75	101 00 002	4
	2.50	101 00 003	2
3102 Lightly Steamed Beech Transparent	0.125	101 00 811	6
	0.375	101 00 812	4
	0.75	101 00 814	4
	2.50	101 00 816	2
3103 Light Oak Transparent	0.125	101 00 801	6
	0.375	101 00 802	4
	0.75	101 00 805	4
	2.50	101 00 807	2
3111 White Transparent	0.125	101 00 092	6
	0.375	101 00 004	4
	0.75	101 00 005	4
	2.50	101 00 006	2
3118 Granite Grey Transparen	0.125	101 00 330	6
	0.375	101 00 332	4
	0.75	101 00 336	4
	2.50	101 00 338	2
3119 Silk Grey Transparent	0.125	101 00 341	6
	0.375	101 00 342	4
	0.75	101 00 344	4
	2.50	101 00 444	2
3123 Pine Transparent	0.125	101 00 093	6
	0.375	101 00 013	4
	0.75	101 00 014	4
	2.50	101 00 015	2
3136 Birch Transparent	0.125	101 00 094	6
	0.375	101 00 075	4
	0.75	101 00 076	4
	2.50	101 00 077	2

Colour code	Can size Litre	Article Number	Unit/pack
3137 Cherry Transparent	0.125	101 00 095	6
	0.375	101 00 078	4
	0.75	101 00 079	4
	2.50	101 00 080	2
3138 Mahogany Transparent	0.125	101 00 096	6
	0.375	101 00 084	4
	0.75	101 00 085	4
	2.50	101 00 086	2
3143 Cognac Transparent	0.125	101 00 270	6
	0.375	101 00 271	4
	0.75	101 00 272	4
	2.50	101 00 273	2
3161 Ebony Transparent	0.125	101 00 098	6
	0.375	101 00 022	4
	0.75	101 00 023	4
	2.50	101 00 024	2
3164 Oak Transparent	0.125	101 00 099	6
	0.375	101 00 031	4
	0.75	101 00 032	4
	2.50	101 00 033	2
3166 Walnut Transparent	0.125	101 00 100	6
	0.375	101 00 081	4
	0.75	101 00 082	4
	2.50	101 00 083	2
3168 Oak Antique Transparent	0.125	101 00 263	6
	0.375	101 00 261	4
	0.75	101 00 262	4
	2.50	101 00 291	2

Upon request also available in 25 L canisters.

Upon request also available in 186 RAL and 2050 NCS colours. Effect, fluorescent and metallic colours are not available.

Standard colours can be mixed to order on tinting machines at your local Osmo dealer.

Wood Wax Finish Intense Colours



	Based on renewable raw materials		Microporous and breathable surface		Resistant to wine, beer, cola
	Easy to clean and maintain		Recoat after approx. 24 hours		24 m²/l 1 coat
	Simple application				

Osmo Wood Wax Finish is suitable for the protection and the decorative finishing of wood in indoor areas: wall panelling, mouldings and beams as well as doors. It is also suitable for edge-glued panels, chipboard and MDF. Ideal as a coloured base coat for wooden flooring and for recoating darkened wood surfaces. Highly recommended for furniture and children's toys.

Methods of Application

Finished surface in 1-2 days, 1-2 coats

1. First coat on the raw, sanded wood approx. 35-45 ml/m².
2. Mistakes in the wet coating can be corrected up to 30 minutes after the first application.
3. Drying time approx. 12 hours (normal climatic conditions, 23 °C/50 % rel. humidity). Lower temperatures and/or higher humidity can increase drying time. Allow for good ventilation.

For a lightly stained effect: within 20 minutes after the application, wipe with a cloth or with a white pad along the wood grain.

Intense: If a more intense colour effect is desired, repeat the application (apply maximum two coats). This only applies to intense colour shades.

As a coloured base coat for flooring: drying time approx. 24 hours (instead of 12 hours; see point 3). Second coat approx. 35-45 ml/m² with a clear Polyx®-Oil. Drying time approx. 8-10 hours; see point 3.

For floors with a white base coat, a top coat with either Osmo Polyx®-Oil Original 3040 White is recommended.

Colour code	Can size Litre	Article Number	Unit/pack
3104 Red (RAL 3000)	0.125	101 00 828	6
	0.375	101 00 830	4
3105 Yellow (RAL 1021)	0.125	101 00 822	6
	0.375	101 00 824	4
3125 Blue (RAL 5010)	0.125	101 00 834	6
	0.375	101 00 836	4
3131 Green	0.125	101 00 840	6
	0.375	101 00 842	4
3132 Grey Beige (RAL 1019)	0.125	101 00 846	6
	0.375	101 00 848	4
	0.75	101 00 850	4
3169 Black	0.125	101 00 451	6
	0.375	101 00 452	4
	0.75	101 00 453	4
	2.50	101 00 454	2

Left: 1 coat.
Right: 2 coats.

Standard colours can be mixed to order on tinting machines at your local Osmo dealer.

Colour code	Can size Litre	Article Number	Unit/pack
3172 Silk	0.125	101 00 375	6
	0.375	101 00 390	4
	0.75	101 00 405	4
3181 Pebble	2.50	101 00 420	2
	0.125	101 00 370	6
	0.375	101 00 385	4
	0.75	101 00 400	4
3186 White matt	2.50	101 00 415	2
	0.125	101 00 379	6
	0.375	101 00 394	4
	0.75	101 00 409	4
	2.50	101 00 424	2
3188 Snow	0.125	101 00 456	6
	0.375	101 00 457	4
	0.75	101 00 458	4
	2.50	101 00 459	2

33



TIP

Fascinating colour effects. The two-tone technique.

On textured wood surfaces, the most fascinating colour effects can be achieved. The most important helper: **Wood Wax Finish from Osmo**. First, prime the surface with a colour of your choice and allow it to dry. Then, apply a second colour to the surface and wipe away excess material with the **Osmo Rubber Scraper** (see page 94). Done!

Learn more at www.osmo.com/uk/inspiration/diy-projects/

Spray-Wax



Sprayable	Based on renewable raw materials	Microporous and breathable surface
Resistant to wine, beer, cola	Recoatable after approx. 6-8 hours	24 m ² /1 l 1 coat
Easy to clean and maintain	Scratch-resistant and hard-wearing	Fast drying

Osmo Spray-Wax is ideal for all timber in indoor areas, for which a durable, low-maintenance and hard-wearing surface is necessary, e.g. stairs, furniture, table tops, kitchen worktops, toys, parquet, flooring etc. Especially well suited for use in wet rooms, such as bathrooms and kitchens.

Methods of Application

Finished surface in 1 day, 2 coats

1. First coat: apply with cup spray gun, RP Technology or Airless/Airmix or HVLP. Application amount depends on the wood species and surface, among other factors, approx. 20-40 ml/m².
2. Allow for good ventilation while drying.
3. Sanding between coats: at least P220
4. Second coat: apply with cup spray gun, RP Technology, Airless/ Airmix or HVLP. Amount depends on the surface, approx. 20-40 ml/m².
5. Ventilate well while drying.
6. Spray parameters: See product information sheet.

Please note for 3009: The desired slip resistance class R9 is only achieved by applying two coats. 3009 must not be evened out with a pad.

34

Colour code	Can size Litre	Article Number	Unit/pack
3009 Clear Semi-matt (R9)	1.00	151 01 001	4
	2.50	151 01 000	2
	10.00	151 01 004	1
	25.00	151 01 006	1
3010 Natural Matt	1.00	151 01 025	4
	2.50	151 01 027	2
	10.00	151 01 031	1
3012 White opaque Satin-gloss	1.00	151 01 016	4
	2.50	151 01 015	2
	10.00	151 01 019	1
3013 Black Opaque Satin-gloss	1.00	151 01 083	4
	2.50	151 01 084	2
	10.00	151 01 086	1
3049 Black Opaque Matt	1.00	150 01 182	4
	2.50	150 01 180	2
	10.00	150 01 181	1
3050 White opaque Matt	1.00	151 01 020	4
	2.50	151 01 021	2
	10.00	151 01 023	1

Colour code	Can size Litre	Article Number	Unit/pack
3066 White transparent	1.00	151 01 011	4
	2.50	151 01 010	2
	10.00	151 01 014	1
3084 Clear Matt	1.00	151 00 901	4
	2.50	151 00 900	2
	10.00	151 00 904	1
3085 Clear Satin	25.00	151 00 910	1
	1.00	151 00 906	4
	2.50	151 00 905	2
3086 Clear Glossy	10.00	151 00 909	1
	25.00	151 00 915	1
	1.00	151 01 071	4
	2.50	101 00 521	2

Upon request also available in 186 RAL and 2050 NCS colours. Effect, fluorescent and metallic colours are not available.

TIP

Two ways, one aim. Colouring Osmo Spray-Wax.

Do you want to colour Osmo Spray-Wax? No problem, Osmo Oil Stain makes it possible. You have the choice between two variations:

1. Apply Oil Stain to the surface with a brush and buff into the surface with a pad. After drying, simply coat with Spray-Wax.
2. Add up to 30 % Oil Stain to Spray-Wax and apply to the surface. The top coat is carried out with a clear Spray-Wax.

Pore Filler Aqua



Waterborne	Sprayable	Microporous and breathable surface
Recoatable after approx. 2 hours	3-5 m ² /l 1 coat	
High filling power	Ready to use	Fast drying

Acts as a base and mid coat on wood and engineered wood products in indoor areas, for example MDF boards.

Colour code	Can size Litre	Article Number	Unit/pack
7036 White Opaque	2.50	111 02 030	2
7037 Grey Opaque	2.50	111 02 032	2

Methods of Application

Finished surface in 1 day, 1 coat (top coat required)

1. First coat: Flow cup spray gun: nozzle: 2.0-2.5mm, vaporiser air pressure: 1.6-2.2 bar; Airless: nozzle: 0.23-0.28 mm, material pressure: 80-120 bar; Airmix: nozzle: 0.23-0.28 mm, material pressure: 80-100 bar, vaporiser air pressure: 1.2-1.8 bar. Application amount depends on engineered wood product and surface quality, among other things, approx. 200-300 ml/m².
2. Drying time: under normal climatic conditions, 23 °C/50 % rel. humidity, dust-dry: approx. 45 minutes; recoatable approx. 2 hours. Forced drying (~50 °C circulating air), dust-dry: approx. 10-15 minutes; recoatable approx. 45-60 minutes.
3. Sand the dry coating, grit P240-P360, and remove any sanding dust.
4. Repeat Steps 1-3 if necessary, for example on highly absorbent substrates such as milled areas or edges of MDF boards.
5. As a high-quality top coat, an opaque Osmo Spray-Wax is recommended.

TIP



The dynamic duo for first class furniture surfaces

Create perfectly oiled furniture surfaces with a combination of **Pore Filler Aqua** and a coloured **Spray Wax**.

In the first step, a levelling priming is carried out with **Pore Filler Aqua**. This highly pigmented, opaque base and intermediate coat with a high solids content for enormous filling and hiding power is based on a modern Aquatec binding agent. With it, wood pores can be completely levelled out without any sinking, shrinkage or cracks.

In the second step, after two hours of drying, **Osmo Spray-Wax** is applied. This natural oil and wax-based coating gives wood a liquid-resistant, low-maintenance, hard-wearing and microporous surface.

TEWS Technology, Hamburg

For the long-lasting protection of the wooden flooring at their new headquarters, the world's leading supplier of highly specialised computer

boards relies on 2K Wood Oil. Sustainability, safety and durability were decisive factors in choosing Osmo.

Extraordinary colour variety

2K Wood Oil for the professional treatment of wood surfaces

2K Wood Oil





Guaranteed **low emissions**

37

Special advantages

- > One-coat application
- > Free of solvents
- > Extremely durable
- > Unlimited colour range
- > Especially suited to public interiors



2K Wood Oil



	Based on renewable raw materials		Microporous and breathable surface		Water and dirt repellent surface
	Resistant to wine, beer, cola		Easy to clean and maintain		40-50 m ² /l 1 coat
	Especially suited for oily and resinous woods		Fast drying		Only 1 coat

Osmo 2K Wood Oil is suitable for all parquet and wooden flooring (solid wood, plank, strip, stairs, etc.) acc. German DIN 18356 as well as furniture surfaces. Especially suitable for oily and resinous hardwoods and commercial interiors, which require the use of a solvent-free product.

Methods of Application

Finished surface in 1 day, 1 coat

- Osmo 2K Wood Oil is not ready to use. Shortly before the application, add the hardener. Ensure that the complete contents of hardener are emptied into the wood coating and that the two components are thoroughly mixed.
- With Osmo Double Blade Scraper, distribute 2K Wood Oil to the surface. On chamfered flooring, apply 2K Wood Oil in sections thinly with Osmo Microfibre Roller, without filling the joints.
- Wait approx. 20-40 minutes for the oil to penetrate the wood.
- Buff oil into the wood and even out the surface with a single disc machine with a white or beige pad.
- Drying time approx. 24 hours (normal climatic conditions, 23 °C/50 % rel. humidity). Lower temperatures and/or higher humidity can increase drying time. Ventilate well.

Colour code	Can size Litre	Article Number	Unit/pack
6100 Clear Matt	0.375	134 00 420	4
	1.00	134 00 422	4
6111 White Matt	0.375	134 00 424	4
	1.00	134 00 426	4
6112 Silver Grey Matt	0.375	134 00 428	4
	1.00	134 00 430	4
6114 Graphite Matt	0.375	134 00 432	4
	1.00	134 00 434	4
6116 Cherry Matt	0.375	134 00 440	4
	1.00	134 00 442	4
6118 Light Grey Matt	0.375	134 00 436	4
	1.00	134 00 438	4

Colour code	Can size Litre	Article Number	Unit/pack
6119 Natural Matt	0.375	134 00 444	4
	1.00	134 00 446	4
6138 Garnet Matt	0.375	134 00 482	4
6141 Havanna Matt	0.375	134 00 448	4
	1.00	134 00 450	4
6143 Cognac Matt	0.375	134 00 452	4
	1.00	134 00 454	4
6164 Tobacco Matt	0.375	134 00 456	4
	1.00	134 00 458	4
6190 Black Matt	0.375	134 00 460	4
	1.00	134 00 462	4

38

TIP

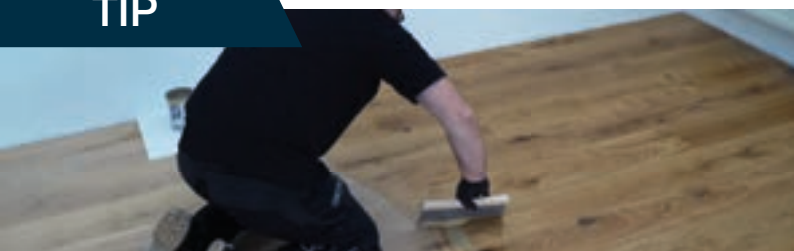

Individualised colour designs

All colours of **2K Wood Oil** can be mixed with each other – this offers you a nearly unlimited design freedom to fulfil your customers' wishes! Trendy colour mixtures and exact mixing ratios can be found on our website: <https://www.osmo.com/uk/inspiration/tips-for-professionals/2k-wood-oil-colour-mixtures>

Thanks to the short drying time as well as the healthy and low-maintenance surface, **2K Wood Oil** is ideally suited to nursery schools, schools, canteens and other public interiors.

Hardener for 2K Wood Oil (6633)



Fast drying

Colour code	Can size Litre	Article Number	Unit/pack
6633 Clear	0.11	134 00 472	6

TIP

When it has to be done really fast – Finished surface with only 1 coat!

No matter whether the coating should be clear or coloured, it is possible for professionals to fulfil customer wishes in the shortest time with only 1 coat – thanks to **2K Wood Oil**.





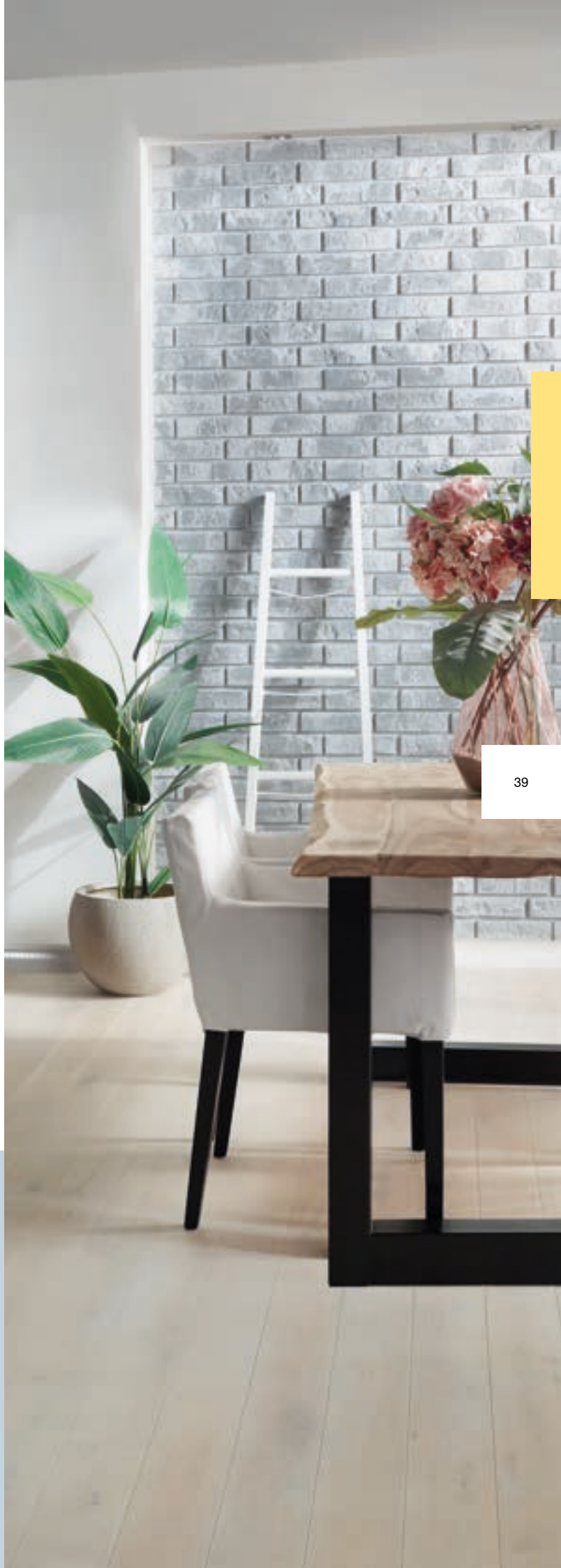



2K Wood Oil is a 2-component oil with an extremely high product coverage and formulated exactly for the needs of professional craftsmen. Not only do the colours create a modern, warm atmosphere, but **2K Wood Oil** also fulfils the desire for the use of a VOC-free product at home.

For applications on furniture surfaces or stairs, **Osmo HandXcenter** can be used. If it is a floor that should be treated, **Osmo FloorXcenter** is to be used.



Oil Stain



 Applications with hardener possible	 Based on renewable raw materials	 Microporous and breathable surface
 Resistant to wine, beer, cola	 Recoatable after approx. 12 hours	 24-48 m ² /1 l 1 coat
 Trowel, brush or roller applications	 Top coat with all Osmo Polyx®-Oils	

Osmo Oil Stain is ideal as a coloured base coat for all wooden floors, such as solid wood, plank, strip, OSB and cork flooring, as well as stairs and furniture surfaces.

Colour code	Can size Litre	Article Number	Unit/pack
3501 White	0.50	151 00 805	4
	1.00	151 00 807	4
	2.50	151 00 809	2
3512 Silver Grey	0.50	151 00 813	4
	1.00	151 00 812	4
	2.50	151 00 814	2
3514 Graphite	0.50	151 00 815	4
	1.00	151 00 817	4
	2.50	151 00 819	2
3516 Jatoba	0.50	151 00 825	4
	1.00	151 00 822	4
	2.50	151 00 824	2
3518 Light Grey	0.50	151 00 843	4
	1.00	151 00 842	4
	2.50	151 00 844	2
3519 Natural	0.50	151 00 848	4
	1.00	151 00 847	4
	2.50	151 00 849	2

Colour code	Can size Litre	Article Number	Unit/pack
3538 Garnet	0.50	151 00 852	4
	1.00	151 00 853	4
3541 Havanna	0.50	151 00 838	4
	1.00	151 00 837	4
	2.50	151 00 839	2
3543 Cognac	0.50	151 00 828	4
	1.00	151 00 827	4
	2.50	151 00 829	2
3564 Tobacco	0.50	151 00 831	4
	1.00	151 00 832	4
	2.50	151 00 834	2
3590 Black	0.50	151 00 803	4
	1.00	151 00 802	4
	2.50	151 00 804	2

Left: 1 coat.
Right: 2 coats.

Methods of Application

Finished surface in 2-3 days, 2-3 coats (1st/2nd Oil Stain, 2nd/3rd clear Polyx®-Oil)

Transparent colour:

1. Apply very thinly to the clean and dry wood along the wood grain with Osmo Floor Brush, Microfibre Roller or Double Blade Scraper.
2. Any brushstrokes can be removed within 30 minutes after applying.
3. Buff into the wood evenly with a white pad.
4. Drying time approx. 12 hours (normal climatic conditions, 23 °C/50 % rel. humidity). Lower temperatures and/or higher humidity can increase drying time. Allow for good ventilation.

Intense colour:

5. Apply the first coat as described in points 1-4.
6. Apply the second coat, also very thinly, as described in point 1.
7. Buff into the wood evenly with a white pad.
8. Drying time approx. 12 hours, see point 4.
9. After Step 4 or 8, apply a top coat with a clear Osmo Polyx®-Oil and leave to dry. For floors with a white base coat, a top coat with either Osmo Polyx®-Oil Original 3040 White is recommended.

Note: Oil Stain can also be applied to smaller surfaces with a lint-free cloth.

TIP



Endless variety. Oil Stain.

With this product, you have the entire coloration literally in your own hands. Depending on what tool you use, completely different colour intensities can be achieved. Whether roller, brush, cloth or Coating Applicator Fleece – every tool brings a different amount of product onto the surface. This makes an enormously wide colour spectrum available – stretching from transparent to intense colours. Endless variety.

Hardener for Oil Stain



Ready to use



Shortened drying time



Ideal for commercial interiors

Osmo Hardener for Oil Stain acts as an additive for Osmo Oil Stain that accelerates the drying process.

Colour code	Can size Litre	Article Number	Unit/pack
6631 Clear	0.06	151 00 528	6

Methods of Application

Finished surface in 1 day, 2-3 coats

1. Open the bottle of Hardener and pour contents into a 1.0 L can of Osmo Oil Stain. Empty the Hardener bottle completely. Stir thoroughly. Processing to be carried corresponds to that of Oil Stain
2. Drying time approx. 4-5 hours (normal climatic conditions, 23 °C/ 50 % rel. humidity). Lower temperatures and/or higher humidity can increase drying time. Allow for good ventilation. (1st and 2nd coat.)
3. Final top coat is to be carried out with a clear Osmo Polyx[®]-Oil.

Note: Pot time is reduced down to 60 minutes by adding Hardener. Please do not mix together more material than you can certainly process within 45 minutes. If you do not use the entire can of Oil Stain, add 6 % Hardener – mix in a separate container!



Healthy and aesthetic

TopOil improves the aesthetics of wood surfaces. It is designed for furniture surfaces in indoor

areas, in particular kitchen surfaces and worktops made of wood with direct contact to food.

For every good taste

TopOil makes water bead up, protects the surface and is food safe.

TopOil

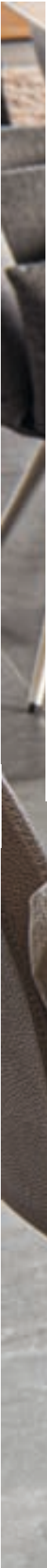



Guaranteed
food safe

Special advantages

- > For kitchen surfaces and worktops, tested food safe as per EN 1186, Part 5/14
- > Especially hard-wearing oil-wax combination
- > Protects wood against dirt and stains from cola, wine and coffee



TopOil

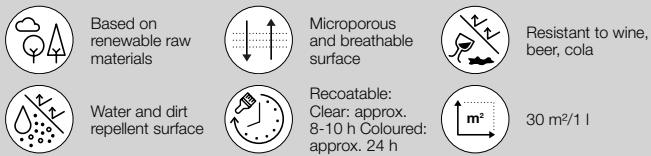

Osmo TopOil is ideal for protecting interior furniture surfaces and work surfaces made of solid wood or edge-glued panels (e.g. kitchen worktops, chopping boards, desktops, shelving etc.). Also suited to cork and OSB.

Colour code	Can size Litre	Article Number	Unit/pack
3028 Clear Satin	0.50	103 00 049	6
3058 Clear Matt	0.50	139 00 050	6
3061 Acacia Matt	0.50	139 00 072	6
3068 Natural Matt	0.50	103 00 061	6
3037 White Satin	0.50	139 00 137	6
3038 Terra Satin	0.50	139 00 138	6
3039 Graphite Satin	0.50	139 00 139	6

Methods of Application

Finished surface in 2 days, 2 coats

1. First coat on sanded raw wood approx. 30-40 ml/m². Apply with a Microfibre Roller, a Flat Brush or a Finish Applicator Fleece from Osmo. (Do not wipe with a cloth afterwards!) Mistakes in the wet coating can be corrected up to 15 minutes after the first application.
2. Drying time approx. 8-10 hours (normal climatic conditions, 20-23°C/50-65 % rel. humidity). Lower temperatures and/or higher humidity can increase drying time. Ventilate well.
3. Second coat approx. 30-40 ml/m². Apply best with a Microfibre Roller, a Flat Brush or a Finish Applicator Fleece.
4. Drying time approx. 8-10 hours; see point 2.
5. Apply further maintenance coats preferably with a Finish Applicator Fleece to avoid applying too much material.

Door-Oil

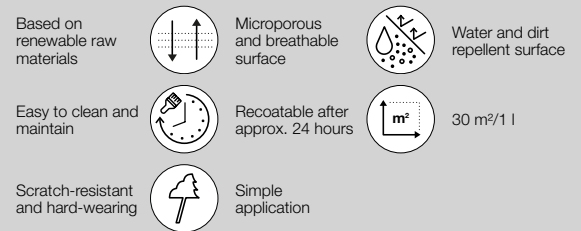

Osmo Door-Oil is ideal for the protection of solid and some selected veneered wood interior doors (please consult door manufacturers' recommendations).

Colour code	Can size Litre	Article Number	Unit/pack
3060 Clear Satin	1.00	139 00 101	6
3033 Raw Matt	1.00	139 00 119	6

Methods of Application

Finished surface in 2 days, 2 coats

1. Apply the first coat thinly and evenly to the clean and dry wood with the wood grain and spread well.
2. Drying time: 3060: approx. 8-10 hours / 3033: approx. 24 hours (normal climatic conditions, 23° C/50 % rel. humidity). Lower temperatures and/or higher humidity can increase drying time. Ventilate well.
3. After drying, apply a second coat - also thinly.
4. Drying time approx. 8-10 hours; see point 2.
5. Note: Remove any visible white pigments before leaving to dry (3033).

44

TIP

Gentle cleaning. Notes on TopOil surfaces.

Surfaces treated with **Osmo TopOil** can be simply wiped clean with a damp cloth. However, we recommend leaving conventional cleaners in the cabinet as these dissolve oils and waxes and so wood protection can no longer be guaranteed. Better performance is delivered with **Osmo Spray Cleaner** because the protective oil layer will not be harmed.



Wood Protector



Based on renewable raw materials	Microporous and breathable surface	Water and dirt repellent surface
Recoatable after approx. 24 hours	6-8,4 m ² /l 1 coat	Simple application
Free of organic biocides	For interior and exterior	

Osmo Wood Protector is suitable for all interior wood, for example wooden flooring made of wood species susceptible to blue stain (e.g. Pine), window frames and wood in bathrooms, as well as exterior wood, for which an absolutely ecological, biocide-free impregnation is desired, for example playground equipment and sandboxes.

Colour code	Can size Litre	Article Number	Unit/pack
4006 Clear	0.75	123 00 001	4
	2.50	123 00 002	2

Methods of Application

Finished surface in 1 day, 1 coat (no stand-alone finish)

1. Apply to raw wood approx 120 ml/m².
2. Drying time approx. 24 hours when applied with a brush or approx. 36 hours when dipped (normal climatic conditions, 23 °C/50 % rel. humidity). Lower temperatures and/or higher humidity can increase drying time. Ventilate well.
3. Final top coat must be carried out within one week.



Uviwax® UV-Protection



Waterborne



Microporous and breathable surface



Easy to clean and maintain



Recoatable after approx. 3-5 hours



16 m²/1 l
1 coat



UV protection, no yellowing



Odourless and supports a healthy living environment



Fast drying

Osmo Uviwax® UV-Protection is suitable for single product applications on wall and ceiling panelling as well as cabinets and doors in indoor areas. It is also suitable for recoating sawn edges and screw holes, additional mouldings, boards etc. that have been factory finished with Osmo Uviwax® UV-Protection. Suitable for all light-coloured wood species.

Colour code	Can size Litre	Article Number	Unit/pack
7200 Clear Satin	0.75	132 00 051	4
	2.50	132 00 050	2
	10.00	132 00 145	1
7266 White Spruce Transparent	0.75	132 00 135	4
	2.50	132 00 136	2
	10.00	132 00 056	1

Upon request also available in 25 L canisters.

Methods of Application

Finished surface in 1 day, 2 coats

1. First coat on the raw, sanded wood approx. 62 ml/m².
2. Drying time approx. 3-5 hours (normal climatic conditions, 23 °C/50 % rel. humidity). Lower temperatures and/or higher humidity can increase drying time. Ventilate well.
3. If desired, the dried finish can be smoothened with fine grain sandpaper (P400) or with a scouring pad before applying the second coat.
4. Second coat approx. 62 ml/m².
5. Drying time approx. 3-5 hours; see point 2.

Maintenance Oil



	Based on renewable raw materials		Microporous and breathable surface		Resistant to wine, beer, cola
	Easy to clean and maintain		Recoat after approx. 3-5 hours		40-60 m ² /l 1 coat
	Ideal for commercial interiors		Routine maintenance without sanding		Fast drying

Methods of Application

Finished surface in 1 day, 1 coat

1. With an Osmo Floor Brush, Flat Brush, Double Blade Scraper or Microfibre Roller, apply to the surface thinly.
2. Buff into the surface with a single disc machine, e.g. Osmo FloorXcenter, and white pad (except for 3098). Remove excess.
3. Ventilate while drying.

Maintenance Oil can also be applied to smaller areas with a lint-free cloth.

For the maintenance and care of all wooden flooring treated with Polyx®-Oil: solid wood, plank, parquet, strip, OSB and cork flooring, as well as stairs and furniture surfaces. Highly recommended for public interiors (e.g. restaurants, museums and other high traffic floors).

Colour code	Can size Litre	Article Number	Unit/pack
3079 Clear Matt	1.00	151 01 040	4
	2.50	151 01 041	2
	10.00	151 01 042	1
3081 Clear Satin	1.00	151 01 045	4
	2.50	151 01 046	2
	10.00	151 01 047	1
3098 Clear Semi-matt (R9)	1.00	151 01 060	4
	2.50	151 01 061	2
	10.00	151 01 062	1
3440 White Transparent	1.00	151 01 043	4
	2.50	151 01 044	2
	10.00	103 00 420	1

TIP

A good basis for more safety. Slip resistance ratings.

The slip resistance of floor coverings is assessed by slip resistance ratings. The aim of these ratings is to ensure effective accident prevention in commercial and public interiors. The German standard DIN 51130 differentiates between five various ratings – from R9 to R13. A few examples:

The **rating R9** meets the lowest requirements for slip resistance and is used for normal floor coverings.

With a higher coefficient of friction, the **rating R11** is, for example, suitable for shop entrances and exterior stairs or also for kitchens in nursery schools or student housing.

The **rating R13** meets the highest requirements for slip resistance to guarantee sure footing on slope angles of up to 35 degrees.

Osmo offers different products, which can produce surfaces with a slip resistance rating of R9 or R11. Among these are **Osmo Polyx®-Oil Anti-Slip (3088, 3089 or 3094)** and **Osmo Maintenance Oil 3098 Anti-Slip**.

Liquid Wax Cleaner



- Microporous and breathable surface
- Resistant to wine, beer, cola
- Easy to clean and maintain
- 80-100 m²/1 l 1 application
- Cleans and regenerates at the same time
- For flooring and furniture
- Spot applications possible

Osmo Liquid Wax Cleaner is ideal for removing tough stains, e.g. grease or shoe polish, and best suited for refreshing all surfaces treated with Osmo Polyx®-Oil.

Colour code	Can size Litre	Article Number	Unit/pack
3029 Clear	0.50	139 00 031	6
	1.00	139 00 002	6
	10.00	139 00 013	1
3087 White	0.50	139 00 067	6
	1.00	139 00 055	6

Methods of Application

Finished surface in one day

1. Remove debris with Dust-Mop or a vacuum cleaner or if necessary, clean the surface with Osmo Wash and Care prior to the treatment.
2. Apply approx. 2 teaspoons per m² to the floor and spread over the area by using an Active Fibre Cloth or a single disc machine (white pad). Apply extremely thinly.
3. Drying time: approx. 30-40 minutes. Ventilate well.
4. In a routine maintenance programme, it is absolutely necessary to restore the essential oil content in the surface finish on flooring treated with Polyx®-Oil. Recoat cleaned areas with especially high traffic with Osmo Maintenance Oil or Polyx®-Oil Original clear.

Liquid Wax Refresher



- For flooring and furniture
- Simple application
- Will not dry out the surface

Osmo Liquid Wax Refresher is ideal for refreshing all wooden surfaces treated with Osmo 2K Wood Oil or Osmo Polyx®-Oil.

Colour code	Can size Litre	Article Number	Unit/pack
3015 Clear	1.00	139 00 168	6

Methods of Application

Finished surface in one day

1. Remove debris with Dust-Mop or a vacuum cleaner or if necessary, clean the surface with Osmo Wash and Care prior to the treatment
2. Shake before use.
3. Dilute with clear water, mixing ratio 1:1
4. Apply on the floor by using a household pump spray bottle.
5. Spread well and spread evenly with an Active Fiber Cloth dampened with water.
6. Drying time: approx. 15 - 20 minutes. Ventilate well.

Wash and Care



Moisturising



For routine cleaning and upkeep



Will not dry out the surface



Concentrate based on natural ingredients

Osmo Wash and Care is especially suitable for the cleaning and care of oiled and waxed wooden flooring. It is also recommended for furniture, doors, wall and ceiling panelling.

Colour code	Can size Litre	Article Number	Unit/pack
8016 Clear	1.00	139 00 030	6
	5.00	139 00 038	1
	10.00	139 00 062	1

Methods of Application

1. Remove debris with a dust mop or a vacuum cleaner
2. Concentrate: 1 capful of Wash and Care to 2 L water. For machine processing (e.g. with FloorXcenter) or a higher level of contamination, the concentration can be increased to a mixing ratio of 1:1.
3. Clean with a slightly damp mop and dry immediately.

Intensive Cleaner



30-100 m²/1 l 1 application



For interior and exterior



Renovation without sanding



Ideal for commercial interiors



High performance concentrate



Deep cleaning power

Osmo Intensive Cleaner is ideal as an alternative to sanding all wooden surfaces treated with oils and waxes, e.g. flooring or furniture, and also suitable for cleaning plastics, stainless steel and other waterproof surfaces.

Colour code	Can size Litre	Article Number	Unit/pack
8019 Clear	1.00	151 01 050	6
	5.00	151 01 055	1

Methods of Application

1. Dilute concentrate with water, 1:10 - 1:20.
2. Apply to contaminated surfaces, loosen deposits and wipe up with clear water. For machine applications on flooring, we recommend using a single disc machine (e.g. Osmo FloorXcenter) with brush ring, red or green pad.
3. Wipe with Osmo Micro-Mop Plush or a lint-free cotton cloth.
4. When completely dried, recoat the cleaned surface with Maintenance Oil or a Polyx®-Oil.

Never apply undiluted. Always perform a trial application on the subsurface. Whether it is necessary to recoat the surface with Maintenance Oil or Polyx®-Oil depends on the condition of surface after cleaning.

TIP



Cleaning – but correctly. The Sinner Circle.

As early as in the 19th Century, the Sinner Circle named after the chemist Dr Herbert Sinner gained great importance in the cleaning of buildings and construction elements.

According to the Sinner Circle, optimal cleaning results from an interaction among four elements: chemistry, mechanics, time and temperature. Using less chemistry, for example, requires more contribution from one or more of the other factors. This is a principle, on which our cleaning and care instructions are based. (See our notes on cleaning and care on pages 14 - 17.)

Spray Cleaner

Anti-Bac Wood Cleaner



Ready to use
 Moisturising
 For routine cleaning and upkeep

Will not dry out the surface

100-150 m²/1 l 1 application
 Simple application
 Will not dry out the surface

Osmo Spray Cleaner is especially suited for the cleaning and maintenance of oiled and waxed wood surfaces in indoor areas. It is particularly recommended for surfaces treated with Osmo TopOil.

Osmo Anti-Bac Wood Cleaner is ideal for the disinfection of wood surfaces, for example flooring, furniture as well as surfaces made of synthetic materials, stainless steel and other waterproof surfaces (e.g. tiles). Suitable for use in private households as well as in restaurants, kitchens, hospitals etc.

Colour code	Can size Litre	Article Number	Unit/pack
8026 Clear	0.50	129 00 084	6

Colour code	Can size Litre	Article Number	Unit/pack
8029 Clear	0.50	129 00 144	6
	5.00	129 00 145	1

Methods of Application

Finished surface in one day

1. Remove debris.
2. Spray onto surface.
3. Clean the surface subsequently with a lint-free cotton cloth and wipe dry.

Methods of Application

1. Remove loose dirt and grime by dust cleaning or vacuuming before wet cleaning for best results.
2. Spray Anti-Bac Wood Cleaner evenly onto the surface and let work for a few minutes, then wipe dry with a clean lint-free cloth or cleaning pad.
3. Rinse disinfected surfaces that come into direct contact with skin or food (e.g. kitchen worktops) with water and wipe to dry.

Wood Filler



Fast drying



Simple application



Recoatable with any Osmo wood finish

Osmo Wood Filler is suitable for patching small cracks, holes and joints in wood.

Colour code	Can size Gram	Article Number	Unit/pack
7300 White	100	135 00 016	6
7301 Beech	100	135 00 012	6
7302 Pine	100	135 00 013	6
7303 Mahogany	100	135 00 014	6
7304 Oak	100	135 00 015	6
7305 Creme White	100	135 00 018	6
7306 Black	100	135 00 019	6

Wood Putty



Eco-friendly



Fast drying



High filling power



Good sanding properties



Low odour

Suitable for filling small cracks (< 2 mm) and small damages (e.g. screw holes) in wooden flooring and parquet. Can be used universally on all wood species. Not suitable for elastic constructions, e.g. plank, sprung, raised and false floors as well as cork flooring.

Colour code	Can size Litre	Article Number	Unit/pack
7350 Clear	1.00	135 00 025	4
	5.00	151 00 025	1

Methods of Application

1. Before preparing the putty in a bucket, stir well and ensure that all sediment is mixed into the putty.
2. Mix in sanding dust, best from the same type of wood with a grit 80-120, into thick paste (approx. 15 % weight increase by adding sanding dust).
3. Fill in flooring diagonally with Osmo Double Blade Scraper or a stainless steel trowel and at the same time press wood putty firmly into joints. Repeat process if necessary.
4. After 30-60 minutes the dried paste can be sanded coarsely (grit P80) and afterwards finely sanded (grit P100-120) so that no wood putty is left on the surface of the parquet. In most cases, fine sanding with P100-120 is enough.
5. Treatment with any oil-and-wax-based wood finish from Osmo can be carried out afterwards.

Note: As wood putty mixture and application strongly depends on wood species and sanding dust, a trial application is absolutely necessary! Do not fill joints in sprung or plank flooring!

TIP

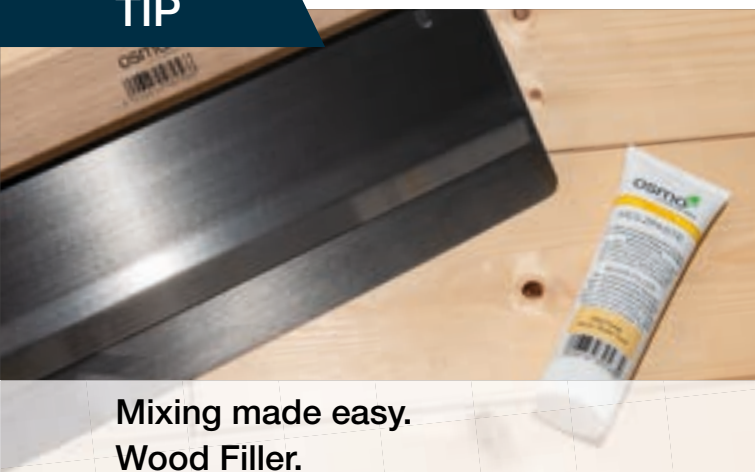

Mixing made easy. Wood Filler.





Cannot find the right colour for your flooring?

Then simply use the colours in the range to mix the suitable colour. Fill joints as usual with the Wood Filler mixture and afterwards treat the area with an **Osmo Polyx®-Oil**.

Paint Stripper

Maintenance Kit for Floors



-  For interior and exterior
-  Simple application
-  Low odour
-  Dissolves and removes synthetic resin lacquers, oil coatings etc.

-  Fully equipped for cleaning and care

Dissolves and removes synthetic resin lacquers, 1-component lacquers, dispersion and latex paints, oil finishes and wood stains, dispersion glues, polymer plasters etc. on solvent-resistant substrates (wood, metal, mineral substrates, such as render, concrete or stone). It has a mild odour and therefore it can be used on large areas in both indoor and outdoor areas.

Osmo Maintenance Kit for Floors is ideal for cleaning and maintaining wooden flooring treated with Polyx®-Oil.

Please follow the work instructions for each individual product.

Colour code	Can size Litre	Article Number	Unit/pack
6000 Clear	1.00	137 00 001	4

Product	Article Number	Unit/pack
Maintenance Kit for Floors	103 00 147	1

Methods of Application

Content

1. Stir Osmo Paint Stripper well – do not thin. Test surface suitability prior to application.
2. With a brush or trowel apply evenly, cover immediately with a thin foil and allow for sufficient reaction time.
3. Test stripping performance occasionally with a trowel and remove dissolved coating layer.
4. Reaction time depends on the coating type, coating thickness and ambient temperature. Remove the soft dissolved layer with a trowel and rinse with warm water, approx. 40 °C.
5. If necessary, repeat the application.

- > Wash and Care cleaning concentrate 1.00 L
- > Liquid Wax Cleaner 0.50 L
- > Cloths 3 pcs.
- > Buffin Fleece

Osmo Maintenance Kit for Stairs

Osmo TopOil Surface Kit



Fully equipped for cleaning and care



Fully equipped for initial treatment, care and restoration

Osmo Maintenance Kit for Stairs is ideal for the cleaning and refreshing as well as the maintenance without sanding of wooden stairs treated with either Polyx®-Oil or Spray-Wax.

Please follow the work instructions for each individual product.

Product	Article Number	Unit/pack
Osmo Maintenance Kit for Stairs	129 00 066	1

Content

- > Wash and Care cleaning concentrate 0.25 L
- > Maintenance Oil clear 0.20 L
- > Application cloths 2 pcs.
- > Buffing pad
- > Gloves 1 pair

Osmo TopOil Surface Kit is ideal for the protection of furniture and worktop surfaces made of solid wood or laminated wood (e.g. kitchen worktops, tabletops, shelving etc.) in indoor areas. Also suitable for cork and OSB.

Please follow the work instructions for each individual product.

Product	Article Number	Unit/pack
Osmo TopOil Surface Kit	129 00 054	1

Content

- > TopOil Clear 3058 0.50 L
- > Spray Cleaner 8026 0.50 L
- > Hand Pad Holder
- > Coating Applicator Fleece
- > Buffing pad
- > Gloves 1 pair

53

TIP



Systematic cleaning and care. Optimal protection for wooden flooring.

Flooring treated with **Osmo Polyx®-Oil** is easy to care – the wax in Polyx®-Oil lies on the wood surface and protects it against the penetration of dirt and moisture. So you can enjoy your wooden flooring for a long time, it is necessary to maintain this protective surface: the maintenance intervals generally depend on the amount of use and wear on the surface. In private households, wooden flooring should be cleaned once a week with a mixture

of water and **Osmo Wash & Care** as well as a damp mop. If the wax layer has been worn away, also refresh walkways and high traffic areas with **Osmo Liquid Wax Cleaner** twice a year. Alternatively **Osmo Maintenance Oil** can also be used. Usually after some years, intensive cleaning with **Osmo Intensive Cleaner** is recommended. After this cleaning, recoat the floor 1x thinly with a **Polyx®-Oil**.





colour & protection | exterior

Product finder

Decking-Oil Anti-Slip Decking Oil Stone and Terracotta Oil End Grain Sealing Wax Natural Oil Woodstain Natural Oil Woodstain Effect Greying Stain UV-Protection-Oil



Page	60	60	61	61	62	63	66	67
Decking	●	●	●	●	●	-	●	-
Privacy screens, fences, pergolas	●	-	-	-	●	●	●	●
Garden sheds, carports	●	-	-	-	●	●	●	●
Garden furniture	●	-	-	-	-	-	-	-
Stairs	●	●	-	-	●	-	●	-
Timber cladding	-	-	-	-	●	●	●	●
Roof overhangs, gables, balconies	●	-	-	-	●	●	●	●
Doors, window shutters	●	-	-	-	●	●	●	●
Playgrounds, sandboxes	●	-	-	-	-	-	-	-

56

Primer Polymer Composite Maintenance Oil WPC & Aluminium Cleaner Wood Reviver Power-Gel Paint Remover Gel Decking Cleaner Garden Furniture Maintenance Kit



Page	82	83	83	84	84	85	85
Decking	-	●	●	●	●	●	-
Privacy screens, fences, pergolas	-	●	●	●	●	-	-
Garden sheds, carports	-	-	-	●	●	-	-
Garden furniture	-	-	-	●	●	-	●
Stairs	-	●	●	●	●	●	-
Timber cladding	●	-	-	●	●	-	-
Roof overhangs, gables, balconies	●	-	-	●	●	-	-
Doors, window shutters	-	-	-	●	●	-	-
Playgrounds, sandboxes	-	-	-	●	●	-	-





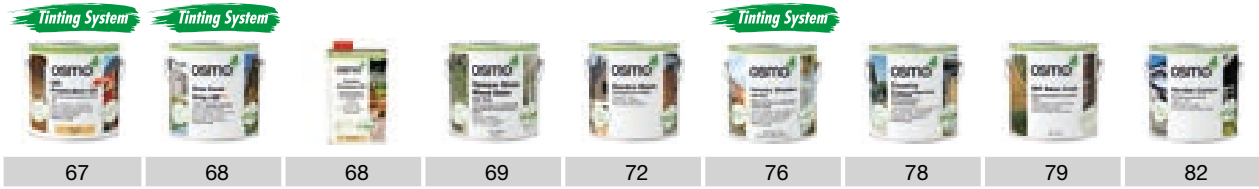

● Suitable for

● Specialist knowledge and tools required

UV- Protection-Oil Extra One Coat Only HS Plus Garden Furniture Oil Opaque Gloss Wood Stain Garden Stain Country Shades Country Colour WR Base Coat Garden Colour



-	-	-	-	-	-	-	●	-
●	●	-	●	●	●	●	●	●
●	●	-	●	●	●	●	●	●
-	●	●	●	●	●	●	-	●
-	-	-	-	-	-	-	●	-
●	●	-	-	●	●	●	●	●
●	●	-	-	●	●	●	●	●
●	-	-	●	●	●	●	●	-
-	●	-	-	●	●	●	-	●

-  Microfiber Roller
-  Flat Brush
-  Flooring/Decking brush
-  Cloth
-  Pad
-  Spray gun

Note: Product coverage varies significantly depending on the condition of the existing wood. All information refers to smooth and planed/cut surfaces. Other surfaces, e.g. grooved or ribbed, may lead to deviations in product coverage. Targeted results may vary depending on the wood species and surface properties; therefore, a trial application is recommended.

Enco Vending, Bulgaria

Exquisite taste is a benchmark at Enco Vending, not only for the automatic coffee machines the company sells, but also for the interiors and

grounds at the company headquarters. For the protection of the exterior wood, the choice was quickly made for Decking-Oil from Osmo.

Perfect outdoor service

The best for wood in outdoor areas – a product that is water and dirt repellent, and also free of biocides.

Decking-Oil





Long-lasting
colour intensity

Special advantages

- > Smoothens wood surfaces
- > Ideal for use on swimming pool decks
- > Will not crack, peel, blister or flake
- > Easy to refresh, no sanding or primer needed



Decking-Oil



- Based on renewable raw materials
- Microporous and breathable surface
- Water and dirt repellent surface
- Recoat after approx. 12 hours
- 24 m²/1 l 1 coat
- Simple application
- Wood grain remains noticeable

Osmo Decking-Oil protects and maintains timber decking, garden furniture and privacy screens made of numerous coniferous and fine woods, such as pressure impregnated Pine, Douglas Fir, Cedar, Oak or Bangkirai – also suitable as a transparent colour treatment of Teak, Eucalyptus and other fine woods as well as thermally treated wood.

Colour code	Can size Litre	Article Number	Unit/pack
004 Douglas Fir	0.75	115 00 018	4
	2.50	115 00 019	2
006 Bangkirai	0.75	115 00 012	4
	2.50	115 00 013	2
007 Teak, Clear	0.375	115 00 004	4
	0.75	115 00 002	4
	2.50	115 00 005	2
009 Larch	0.75	115 00 020	4
	2.50	115 00 021	2
010 Thermowood	0.75	115 00 043	4
	2.50	115 00 045	2
013 Garapa	0.75	115 00 081	4
	2.50	115 00 082	2
014 Massaranduba	0.75	115 00 084	4
	2.50	115 00 085	2
016 Bangkirai Dark	0.75	115 00 063	4
	2.50	115 00 062	2
019 Grey	0.75	115 00 141	4
	2.50	115 00 142	2
021 Bog Oak	0.75	115 00 154	4
	2.50	115 00 156	2

Upon request also available in 25 L canisters.

Standard colours and additional colours can be mixed to order on tinting machines at your local Osmo dealer.

Methods of Application

Finished surface in 2 days, 2 coats

- First coat thinly applied to dried, raw (weathered) wood approx. 35-45 ml/m².
Note: Resinous woods and hardwoods rich in extractives first need to weather.
- Mistakes in the wet coating can be corrected up to 30 minutes after the first application.
- Drying time approx. 12 hours (normal climatic conditions, 23 °C/ 50 % rel. humidity). Lower temperatures and/or higher humidity can increase drying time. Ventilate well.
- Second coat approx. 35-45 ml/m². For renovations, normally one coat on the cleaned surface is sufficient.
- Drying time approx. 12 hours; see point 3.

Note: Osmo Decking-Oil 007 Teak is clear and therefore it does not protect wood against UV radiation from the sun (greying)! Aged, ribbed or grooved wood may have a significantly higher material requirement.

Anti-Slip Decking Oil



- Based on renewable raw materials
- Coating protected against mould, algae and fungal attack
- Microporous and breathable surface
- Non-slip surface through anti-slip additives
- Recoat after approx. 12 hours
- 24 m²/1 l 1 coat

Osmo Anti-Slip Decking Oil is especially suited for all timber decking and stairs in outdoor areas made of e.g. Bangkirai, Massaranduba, Garapa, Larch, Douglas Fir or Pine. Suitable for ribbed, grooved and particularly for smooth decking surfaces.

Colour code	Can size Litre	Article Number	Unit/pack
430 Clear Satin	0.75	115 00 074	4
	2.50	115 00 073	2

Methods of Application

Finished surfaces in 2 days, 2 coats (pigmented base coat required)

(1st coat pigmented Decking-Oil, 2nd coat Anti-Slip Decking Oil)

- First pigmented coat with an Osmo Decking-Oil on raw wood approx. 35-45 ml/m².
- Mistakes in the wet coating can be corrected up to 15 minutes after the first application.
- Drying time approx. 24 hours (normal climatic conditions, 23 °C/50 % rel. humidity). Lower temperatures and/or higher humidity can increase drying time. Ventilate well.
- Second coat (top coat) approx. 35-45 ml/m² with Anti-Slip Decking Oil. For renovations, normally one coat on the cleaned surface is sufficient.
- Drying time approx. 12 hours; see point 3.
- Not suitable for Osmo Decking Oil 007 Teak.

TIP

Fresh as on day one. Decking upkeep.

Exterior wood is exposed to natural weathering conditions, and therefore, it can turn grey over time. No problem with Osmo – with water and **Osmo Wood Reviver Power-Gel**, such surfaces can be cleaned and restored in no time. For professionals, we recommend Osmo Decking and Flooring Cleaning Machine.

Our tip: preserve the now restored natural wood colour by treating the surface with an Osmo wood coating. **Osmo Decking-Oil** and **Osmo Natural Oil Woodstain** are perfect for such jobs. For the top coat, we recommend our **Anti-Slip Decking Oil**.

Stone and Terracotta Oil

End Grain Sealing Wax



- Based on renewable raw materials
- Microporous and breathable surface
- Water and dirt repellent surface
- Easy to clean and maintain
- Recoat after approx. 8-10 hours
- 32 m²/1 l 1 coat
- Enhances the colour of the substrate

- Based on renewable raw materials
- Water and dirt repellent surface
- Reduces swelling and shrinkage
- Recoat after approx. 4-6 hours
- 5 m²/1 l 1 coat
- Protects end grains against cracks and splitting
- Free of water and silicones

Osmo Stone and Terracotta Oil is suitable for the clear impregnation of microporous natural stone with a polished, sanded or break surface and artificial stone in outdoor areas. Especially suited for paving and windowsills made of granite as well as limestone and slate.

Osmo End Grain Sealing Wax is especially suited for the end grains of decking, cladding or roof soffits made of hard and softwoods, such as Bangkirai, Teak, Massaranduba, Garapa, Cumaru as well as Pine, Spruce, Douglas Fir, Larch, Cedar, Thermowood etc.

Colour code	Can size Litre	Article Number	Unit/pack
620 Clear Satin	0.75	115 00 112	4
	2.50	115 00 113	2

Colour code	Can size Litre	Article Number	Unit/pack
5735 Clear Satin	0.375	103 00 151	4

Left: on stone.

Right: on terracotta.

Methods of Application

Finished surface in 2 days, 2 coats

- With Osmo Flat Brush, Floor Brush, Coating Applicator Fleece or Microfibre Roller, apply very thinly and spread well. Remove excess with a pad or lint-free cloth.
- Drying time approx. 8-10 hours (normal climatic conditions, 23 °C / 50 % rel. humidity). Lower temperatures and/or higher air humidity can increase the drying time. Ventilate well while drying.
- Apply the second coat also very thin. Remove any excess with a pad or a lint-free cloth. Then renovating already oiled surfaces, normally one coat on a cleaned surface is sufficient.
- Drying time approx. 8-10 hours; see point 2.

Methods of Application

- Apply first coat generously, wet on wet, on raw end grain approx. 150-200 ml/m².
- Drying time approx. 3-4 hours (normal climatic conditions, 23 °C / 50 % rel. humidity). Lower temperatures and/or higher humidity can increase drying time. Ventilate well.
- Second coat approx. 150-200 ml/m².
- Drying time approx. 3-4 hours; see point 2.



Natural Oil Woodstain



	Based on renewable raw materials		Microporous and breathable surface		Coating protected against mould, algae and fungal attack
	Water and dirt repellent surface		For dimensionally stable / unstable exterior wood		Recoatable after approx. 4-6 hours
	26 m ² /1 l 1 coat				

Osmo Natural Oil Woodstain is ideal for all wood in outdoor areas: doors, windows and window shutters (dimensionally stable elements), carports, timber cladding, balconies, timber decking, fences, pergolas, garden furniture and garden sheds (dimensionally unstable elements).

Methods of Application

Finished surface in 1 day, 2 coats

1. First coat on raw wood approx 35-45 ml/m².
2. Mistakes in the wet coating can be corrected up to 15 minutes after the first application.
3. Drying time approx. 4-6 hours (normal climatic conditions, 23 °C/50 % rel. humidity). Lower temperatures and/or higher humidity can increase drying time. Ventilate well.
4. Second coat approx. 35-45 ml/m². For renovations, normally one coat on the cleaned surface is sufficient.
5. Drying time approx. 12 hours; see point 3.

701 Clear Matt without UV protection

Colour code	Can size Litre	Article Number	Unit/pack
700 Pine Transparent	0.75	121 00 001	4
	2.50	121 00 002	2
701 Clear Matt	0.75	121 00 075	4
	2.50	121 00 085	2
702 Larch Transparent	0.75	121 00 055	4
	2.50	121 00 056	2
703 Mahogany Transparent	0.75	121 00 004	4
	2.50	121 00 005	2
706 Oak Transparent	0.75	121 00 007	4
	2.50	121 00 008	2
707 Walnut Transparent	0.75	121 00 010	4
	2.50	121 00 011	2
708 Teak Transparent	0.75	121 00 013	4
	2.50	121 00 014	2
710 Stone Pine Transparent	0.75	121 00 097	4
	2.50	121 00 096	2
712 Ebony Transparent	0.75	121 00 017	4
	2.50	121 00 018	2
727 Rosewood Transparent	0.75	121 00 035	4
	2.50	121 00 036	2

Colour code	Can size Litre	Article Number	Unit/pack
728 Cedar Transparent	0.75	121 00 038	4
	2.50	121 00 039	2
731 Oregon Pine Transparent	0.75	121 00 254	4
	2.50	121 00 256	2
732 Light Oak Transparent	0.75	121 00 264	4
	2.50	121 00 266	2
739 Silver Grey Transparent	0.75	122 00 095	4
	2.50	122 00 097	2
900 White Transparent	0.75	121 00 023	4
	2.50	121 00 024	2
903 Basalt Grey Transparent	0.75	121 00 026	4
	2.50	121 00 027	2
905 Patina Transparent	0.75	121 00 150	4
	2.50	121 00 151	2
906 Pearl Grey Transparent	0.75	121 00 274	4
	2.50	121 00 276	2
907 Quartz Grey Transparent	0.75	121 00 284	4
	2.50	121 00 286	2

Upon request also available in 25 L canisters.

Upon request also available in 186 RAL and 1950 NCS colours. Effect, fluorescent and metallic colours are not available.

Standard colours as well as Elements®, RAL, NCS and BS colours can be mixed to order on tinting machines at your local Osmo dealer. Natural Oil Woodstain colours mixed to order are available in Matt and Satin sheens.

TIP

Blotchy surfaces – we have something that can help.

Follow-up treatment with Natural Oil Woodstain.

Wood is a natural product, which sometimes responds differently than desired. For instance, it could be that a substrate does not absorb the wood coating evenly. The result is an uneven colour. We have something that can help – **Osmo Natural Oil Woodstain 701 Clear Matt**. A follow-up treatment with this product dulls glossy spots and ensures an even and elegant appearance.

Natural Oil Woodstain Effect



Based on renewable raw materials



Microporous and breathable surface



Coating protected against mould, algae and fungal attack



Water and dirt repellent surface



Recoatable after approx. 4-6 hours



26 m²/1 l
1 coat



For dimensionally stable / unstable exterior wood

Osmo Natural Oil Woodstain is ideal for all wood in outdoor areas: doors, windows and window shutters (dimensionally stable elements), carports, timber cladding, balconies, fences, pergolas, garden furniture and garden sheds (dimensionally unstable elements).

Colour code	Can size Litre	Article Number	Unit/pack
1140 Agate-Silver Transparent	0.75	121 00 230	4
	2.50	121 00 231	2
1142 Graphite Silver Transparent	0.75	121 00 242	4
	2.50	121 00 243	2
1143 Onyx Silver Transparent	0.75	121 00 248	4
	2.50	121 00 249	2

Methods of Application

Finished surface in 1 day, 2 coats

1. First coat on raw wood approx 35-45 ml/m².
2. Mistakes in the wet coating can be corrected up to 15 minutes after the first application.
3. Drying time approx. 4-6 hours (normal climatic conditions, 23 °C/50 % rel. humidity). Lower temperatures and/or higher humidity can increase drying time. Ventilate well.
4. Second coat approx. 35-45 ml/m². For renovations, normally one coat on the cleaned surface is sufficient.
5. Drying time approx. 12 hours; see point 3.

TIP



Silvery elegance.

Artificial greying with Osmo stains.

There are two ways to counteract the natural greying process of wood surfaces. Either clean and restore the surfaces to the original colour (see our tip on page 60) or treat them with grey and silver shimmering stains from Osmo. They offer an especially elegant solution, with which wood surfaces shine in a modern grey from the very beginning, without waiting for the natural greying process.



Grey in various shades has been on-trend for the design of cladding, garden sheds, carports and privacy fencing for many years now. However, not all greys are alike – the new Greying Stain coats wood surfaces in various nuances.

Eight different matt colours offer a multitude of design variations, especially for classic and square-edged wood elements. Grey has a lot of potential.

Not all greys are alike.

With the new Greying Stain, characterful wood grain stays visible. It gives wood an even grey, matt appearance.

Greying Stain





Elegant grey

– from the very beginning

Special advantages:

- > Creates a uniformly grey appearance
- > Protects against weathering
- > Naturally matt surface



Greying Stain

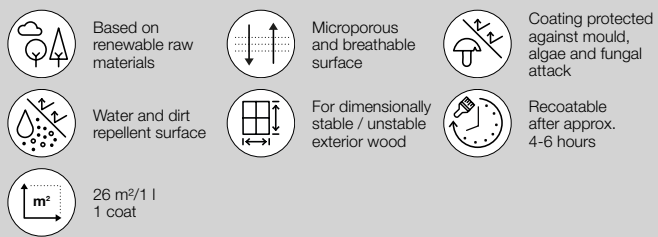

Osmo Greying Stain is ideal for all wood in outdoor areas: doors, windows and window shutters (dimensionally stable elements), carports, timber cladding, balconies, timber decking, fences, pergolas and garden sheds (dimensionally unstable elements).

Colour code	Can size Litre	Article Number	Unit/pack
1919 Sand Grey Matt Transparent	0.75	114 00 812	4
	2.50	114 00 813	2
1920 Lava Grey Matt Transparent	0.75	114 00 819	4
	2.50	114 00 820	2
1921 Platinum Grey Matt Transparent	0.75	114 00 825	4
	2.50	114 00 826	2
1922 Silk Grey Matt Transparent	0.75	114 00 831	4
	2.50	114 00 832	2
1923 Reed Grey Matt Transparent	0.75	114 00 837	4
	2.50	114 00 838	2
1924 Patina Grey Matt Transparent	0.75	114 00 841	4
	2.50	114 00 842	2
1925 Pearl Grey Matt Transparent	0.75	114 00 845	4
	2.50	114 00 846	2
1926 Quartz Grey Matt Transparent	0.75	114 00 849	4
	2.50	114 00 850	2

Methods of Application

Finished surface in 1 day, 2 coats

1. First coat on raw wood approx. 35-45 ml/m².
2. Mistakes in the wet coating can be corrected up to 15 minutes after the first application.
3. Drying time approx. 4-6 hours (normal climatic conditions, 23 °C/50 % rel. humidity). Lower temperatures and/or higher humidity can increase drying time. Ventilate well.
4. Second coat approx. 35-45 ml/m². For renovations, normally one coat on the cleaned surface is sufficient.
5. Drying time approx. 12 hours; see point 3.

TIP



Timeless elegance

Give wood timeless elegance with innovative **Greying Stain**.

Protect surfaces against weather influences and enjoy an elegant, grey patina from the very beginning.

UV-Protection-Oil

UV-Protection-Oil Extra



Based on renewable raw materials	Microporous and breathable surface	Water and dirt repellent surface
For dimensionally stable / unstable exterior wood	Recoatable after approx. 12 hours	18 m²/1 l 1 coat
Without film protection		

Based on renewable raw materials	Microporous and breathable surface	Coating protected against mould, algae and fungal attack
For dimensionally stable / unstable exterior wood	Recoatable after approx. 12 hours	18 m²/1 l 1 coat
With film protection		

Osmo UV-Protection-Oil is ideal for all vertical wood surfaces in outdoor areas: doors, windows, window shutters (dimensionally stable elements), carports, wood siding, balconies, fences, pergolas, and garden sheds (dimensionally unstable elements).

Osmo UV-Protection-Oil is ideal for all vertical wood surfaces in outdoor areas: doors, windows, window shutters (dimensionally stable elements), carports, wood siding, balconies, fences, pergolas, and garden sheds (dimensionally unstable elements).

Colour code	Can size Litre	Article Number	Unit/pack
410 Clear Satin	0.75	116 00 021	4
	2.50	116 00 022	2

Colour code	Can size Litre	Article Number	Unit/pack
420 Clear Satin	0.75	116 00 026	4
	2.50	116 00 027	2
424 Spruce Satin	0.75	116 00 049	4
	2.50	116 00 057	2
425 Oak Satin	0.75	116 00 033	4
	2.50	116 00 034	2
426 Larch Satin	0.75	116 00 062	4
	2.50	116 00 063	2
427 Douglas Fir Satin	0.75	116 00 068	4
	2.50	116 00 069	2
428 Red Cedar Satin	0.75	116 00 041	4
	2.50	116 00 042	2
429 Natural Satin	0.75	116 00 051	4
	2.50	116 00 052	2
431 Light Red Cedar Satin	0.75	116 00 081	4
	2.50	116 00 082	2
432 Light Oak Satin	0.75	116 00 092	4
	2.50	116 00 093	2
1420 Clear Matt	0.75	116 00 104	4
	2.50	116 00 106	2

Methods of Application

Finished surface in 2 days, 2 coats

1. First coat on raw wood approx. 55 ml/m².
2. Mistakes in the wet coating can be corrected up to 15 minutes after the first application.
3. Drying time approx. 10-12 hours (normal climatic conditions, 23 °C/ 50 % rel. humidity). Lower temperatures and/or higher humidity can increase drying time. Ventilate well.
4. Second coat approx. 55 ml/m².
5. Drying time approx. 12 hours; see point 3.

Upon request also available in 25 L canisters.

Methods of Application

Finished surface in 2 days, 2 coats

1. First coat on raw wood approx. 55 ml/m².
2. Mistakes in the wet coating can be corrected up to 15 minutes after the first application.
3. Drying time approx. 10-12 hours (normal climatic conditions, 23 °C/ 50 % rel. humidity). Lower temperatures and/or higher humidity can increase drying time. Ventilate well.
4. Second coat approx. 55 ml/m².
5. Drying time approx. 12 hours; see point 3.

One Coat Only HS^{Plus}



- Based on renewable raw materials
- Microporous and breathable surface
- Water and dirt repellent surface
- Recoat after approx. 12 hours
- 26 m²/l 1 coat
- High coverage thanks to high solids content
- Only 1 coat
- Free of biocides

Osmo One Coat Only HS^{Plus} is ideal for the protection of all wood in outdoor areas: carparks, timber cladding, balconies, fences, pergolas, garden furniture and garden sheds. Well-suited for renewing old microporous finishes.

Colour code	Can size Litre	Article Number	Unit/pack
9203 Basalt Grey Transparent	0.75	111 01 542	4
	2.50	111 01 544	2
9205 Patina Transparent	0.75	111 01 552	4
	2.50	111 01 554	2
9206 Light Oak Transparent	0.75	111 01 562	4
	2.50	111 01 564	2
9207 Quartz Grey Transparent	0.75	111 01 572	4
	2.50	111 01 574	2
9211 White Spruce Transparent	0.75	111 01 060	4
	2.50	111 01 065	2
9212 Silver Poplar Transparent	0.75	111 01 450	4
	2.50	111 01 455	2
9221 Pine Transparent	0.75	111 01 480	4
	2.50	111 01 485	2
9235 Red Cedar Transparent	0.75	111 01 030	4
	2.50	111 01 035	2
9236 Larch Transparent	0.75	111 01 210	4
	2.50	111 01 215	2
9241 Oak Transparent	0.75	111 01 390	4
	2.50	111 01 395	2
9261 Walnut Transparent	0.75	111 01 360	4
	2.50	111 01 365	2
9262 Teak Transparent	0.75	111 01 420	4
	2.50	111 01 425	2
9264 Rosewood Transparent	0.75	111 01 120	4
	2.50	111 01 125	2
9271 Ebony Transparent	0.75	111 01 270	4
	2.50	111 01 275	2

Upon request also available in 25 L canisters.

Methods of Application

Finished surface in 1 day, 1 coat

1. First coat on raw wood approx. 35-45 ml/m².
2. Mistakes in the wet coating can be corrected up to 15 minutes after the first application.
3. Drying time approx. 12 hours (normal climatic conditions, 23 °C/50 % rel. humidity). Lower temperatures and/or higher humidity can increase drying time. Ventilate well.

Garden Furniture Oil



- Based on renewable raw materials
- Microporous and breathable surface
- Water and dirt repellent surface
- Recoat after approx. 12 hours
- 24 m²/l 1 coat

Osmo Garden Furniture Oil protects, maintains and improves the appearance of furniture made of wood – in covered outdoor areas. It is also well-suited for the clear treatment of garden furniture and other similarly used surfaces.

Colour code	Can size Litre	Article Number	Unit/pack
028 Clear	1.00	115 00 130	6

Methods of Application

Finished surface in 2 days, 2 coats

1. With a stiff brush (Osmo Flat Brush) or a lint free cloth, apply thinly and evenly to the clean and dry wood surface. Always work with wood grain. Apply thinly and evenly.
2. Drying time: approx. 12 hours (normal climatic conditions, 23 °C/50 % rel. humidity). Ventilate well while drying. Lower temperatures and/or higher air humidity may increase drying times. After 2-3 weeks, the surface is fully cured. Ventilate well.
3. Then apply the second coat – also thinly.
4. Note: Osmo Garden Furniture Oil is clear and therefore it does not protect wood against UV radiation from the sun (greying)! Aged wood may have a significantly higher material requirement.

TIP



Transparent look. The advantages of a wood stain.

A stain is a coating under which the wood grain can still be clearly recognised. Wood stains can be oil-based or waterborne – depending the colour tone, they produce either a clear or transparent colour surface protection. Clear means, that although the coating does not contain any pigments, the wood is still sufficiently protected. A satin coat creates a slight sheen on the surface – a matt coat, on the other hand, makes the surface look very natural.

Opaque Gloss Wood Stain



	Based on renewable raw materials		Microporous and breathable surface		Water and dirt repellent surface
	For dimensionally stable / unstable exterior wood		Recoat after approx. 6 hours		20 m ² /1 l 1 coat
	Especially developed for windows and doors				

Osmo Opaque Gloss Wood Stain is especially suitable for all wood in indoor and outdoor areas. Ideal for coating or recoating dimensionally stable elements, such as windows, window shutters and doors, as well as dimensionally unstable elements, such as roof soffits, fences, screens, pergolas, posts, garden gazebos, greenhouses and garden furniture.

Colour code	Can size Litre	Article Number	Unit/pack
2104 White Opaque	0.75	112 00 002	4
	2.50	112 00 003	2

Methods of Application

Finished surface in 2 days, 2 coats

1. First coat on raw wood approx. 45 ml/m².

2. Mistakes in the wet coating can be corrected up to 15 minutes after the first application.

3. Drying time approx. 10-12 hours (normal climatic conditions, 23 °C/50 % rel. humidity). Lower temperatures and/or higher humidity can increase drying time. Ventilate well.

4. Second coat approx. 45 ml/m².

5. Drying time approx. 12 hours; see point 3.

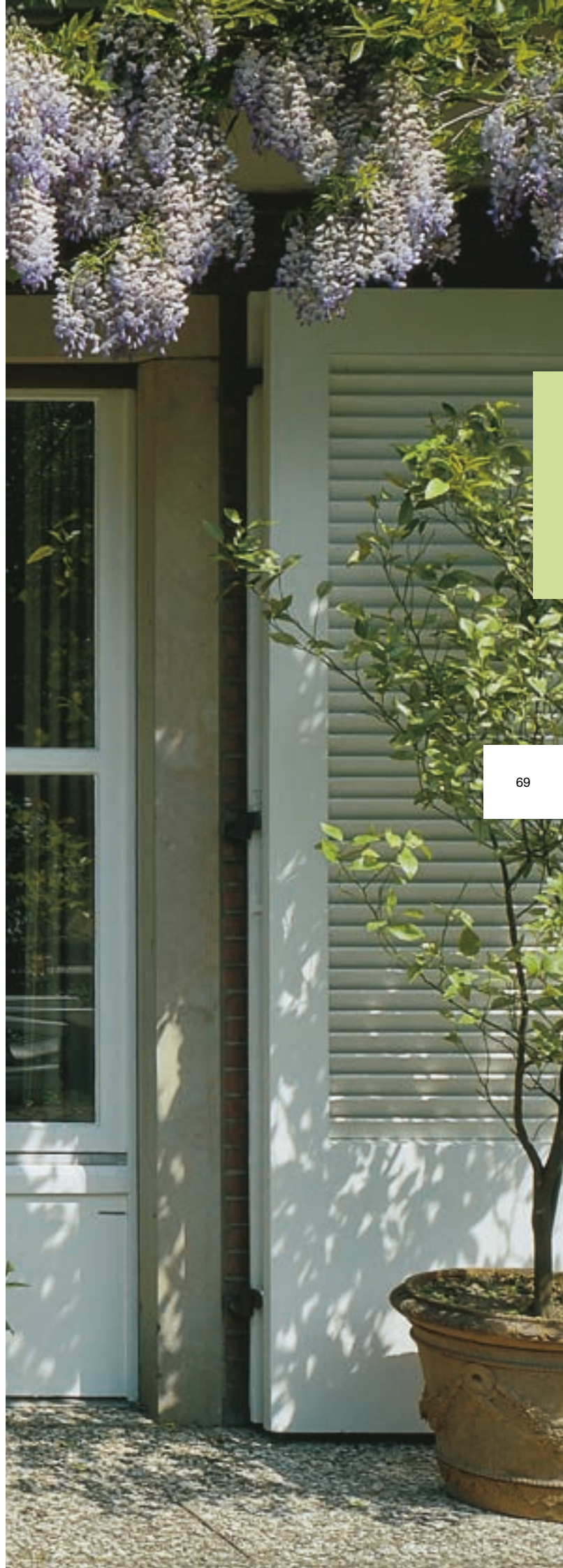

The transparent alternative

A natural look thanks to a transparent stain and a harmless surface – no problem for Garden Stain. This product also has a simple application and a

short drying time. Two coats in one day make it unbelievably efficient and economical.

Extremely weather-resistant and exceedingly high product coverage

Effective surface protection in current grey and brown shades – for perfect results

Garden Stain





Dries
extremely fast

Special advantages:

- > Long durability
- > Extremely short drying time
- > Sprayable
- > Low solvent content
- > Suitable for nursery schools and children's playgrounds

osmo

Garden Stain

Fast drying wood coating

Transparent - satin
Fast drying - sprayable
Will not crack, flake or peel

Low
solvent
content

Garden Stain

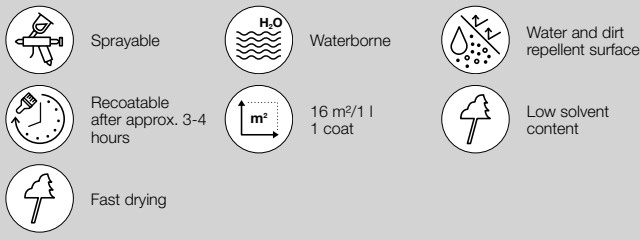

Osmo Garden Stain is best suited for every exterior wood (except for decking): timber cladding, balconies, window shutters, fencing, pergolas, sheds, garden furniture, carports.

Colour code	Can size Litre	Article Number	Unit/pack
7247 Pine transparent	0.75	131 00 366	4
	2.50	131 00 367	2
7248 Light Oak transparent	0.75	131 00 369	4
	2.50	131 00 370	2
7249 Teak transparent	0.75	131 00 372	4
	2.50	131 00 373	2
7251 Rosewood transparent	0.75	131 00 375	4
	2.50	131 00 376	2
7252 Larch transparent	0.75	131 00 378	4
	2.50	131 00 379	2
7253 Patina transparent	0.75	131 00 381	4
	2.50	131 00 382	2
7254 Pearl Grey transparent	0.75	131 00 384	4
	2.50	131 00 385	2
7255 Basalt Grey transparent	0.75	131 00 387	4
	2.50	131 00 388	2

Methods of Application

Finished surface in 1 day, 2 coats

1. With Osmo Flat Brush, Microfibre Roller or Coating Applicator Fleece, apply thinly and quickly lap for lap with the grain or in a spray application and spread well with a Flat Brush.
2. Leave to dry for approx. 3-4 hours under good ventilation.
3. After drying, carry out the second coat, also thin and quickly. For renovations, one coat is sufficient.

TIP

Looking for additional protection against rot, blue stain and pests?

For a chemical wood protection, pre-treat raw wood with **Osmo WR Base Coat 4001**.



Air, Earth, Fire and Water

Elements® is a collection of 120 bespoke colours inspired by the elements of nature: air, earth, fire and water. Created with a passion for nature and how it affects our wellbeing as well as the positive

impact colour choices have on personal spaces and expression. Osmo Country Shades, Natural Oil Woodstain and Wood Wax Finish can be mixed in Elements® colours at selected stores.

Pure design

Bespoke colours mixed directly in the store, a high solids content and safe ingredients: pure Osmo quality.

Country Shades





Endless

colour variety for the exterior

Special advantages

- > Extremely durable
- > 120 Elements® as well as 4800 RAL and BS colours mixed directly in the store
- > Suitable for playground equipment and nursery schools
- > Recoatable without any previous sanding



Country Shades



	Based on renewable raw materials		Microporous and breathable surface		Water and dirt repellent surface
	For dimensionally stable / unstable exterior wood		Recoat after approx. 12 hours		26 m ² /1 l 1 coat
	Robust to small damages				

Osmo Country Shades is best suited for all wood in outdoor areas where an especially durable coating is required: timber cladding, balconies, windows and window shutters, fences, pergolas, wooden shingles, garden furniture and garden sheds, carports etc. Ideal for renewing old microporous finishes and weathered wooden surfaces.

Colour code	Can size Litre	Article Number	Unit/pack
2954 Base Clear Base	0.75	114 00 501	4
2954 Base Clear Base	2.50	114 00 500	2
2955 Base White transp. Base	0.75	114 00 504	4
2955 Base White transp. Base	2.50	114 00 503	2
2956 Base White Opaque Base	0.75	114 00 507	4
2956 Base White Opaque Base	2.50	114 00 506	2

Methods of Application

Finished surface in 2 days, 2 coats

1. First coat on raw wood approx. 35-45 ml/m².
2. Mistakes in the wet coating can be corrected up to 15 minutes after the first application.
3. Drying time approx. 10-12 hours (normal climatic conditions, 23 °C/50 % rel. humidity). Lower temperatures and/or higher humidity can increase drying time. Allow for good ventilation.
4. Second coat approx. 35-45 ml/m². (For renovation works, normally one coat on a cleaned surface is sufficient.)
5. Drying time approx. 12 hours; see point 3.

Air

A01	A02
A03	A04
A05	A06
A07	A08
A09	A10
A11	A12
A13	A14
A15	A16
A17	A18
A19	A20
A21	A22
A23	A24
A25	A26
A27	A28
A29	A30

Earth

E31	E32
E33	E34
E35	E36
E37	E38
E39	E40
E41	E42
E43	E44
E45	E46
E47	E48
E49	E50
E51	E52
E53	E54
E55	E56
E57	E58
E59	E60



Fire

F61	F62		
F63	F64	F65	F66
F67	F68	F69	F70
F71	F72	F73	F74
F75	F76	F77	F78
F79	F80	F81	F82
F83	F84	F85	F86
F87	F88	F89	F90

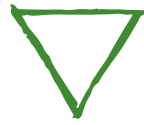

Water

W91	W92		
W93	W94	W95	W96
W97	W98	W99	W100
W101	W102	W103	W104
W105	W106	W107	W108
W109	W110	W111	W112
W113	W114	W115	W116
W117	W118	W119	W120



Country Colour

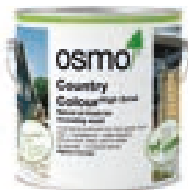

	Based on renewable raw materials		Microporous and breathable surface		Water and dirt repellent surface
	For dimensionally stable / unstable exterior wood		Recoat after approx. 12 hours		26 m ² /1 l 1 coat
	Robust to small damages				

Osmo Country Colour is best suited for all wood in outdoor areas where an especially durable coating is required: timber cladding, balconies, windows and window shutters, fences, pergolas, wooden shingles, garden furniture and garden sheds, carpports etc. Ideal for renewing old microporous finishes and weathered wooden surfaces.

Methods of Application

Finished surface in 2 days, 2 coats

1. First coat on raw wood approx. 35-45 ml/m².
2. Mistakes in the wet coating can be corrected up to 15 minutes after the first application.
3. Drying time approx. 10-12 hours (normal climatic conditions, 23 °C/50 % rel. humidity). Lower temperatures and/or higher humidity can increase drying time. Ventilate well.
4. Second coat approx. 35-45 ml/m². For renovations, normally one coat on the cleaned surface is sufficient.
5. Drying time approx. 12 hours; see point 3.

Colour code	Can size Litre	Article Number	Unit/pack
2101 White Opaque	0.75	114 00 027	4
	2.50	114 00 028	2
2203 Light Ochre Opaque	0.75	114 00 017	4
	2.50	114 00 018	2
2204 Ivory Opaque	0.75	114 00 036	4
	2.50	114 00 037	2
2205 Sunflower Yellow Opaque	0.75	114 00 059	4
	2.50	114 00 058	2
2308 Nordic Red Opaque	0.75	114 00 030	4
	2.50	114 00 031	2
2310 Cedar/Redwood Opaque	0.75	114 00 068	4
	2.50	114 00 069	2
2311 Signal Red Opaque	0.75	114 00 126	4
	2.50	114 00 128	2
2404 Fir Green Opaque	0.75	114 00 003	4
	2.50	114 00 004	2
2501 Labrador Blue Opaque	0.75	114 00 005	4
	2.50	114 00 006	2
2506 Royal Blue Opaque	0.75	114 00 072	4
	2.50	114 00 073	2

Upon request also available in 25 L canisters.

Colour code	Can size Litre	Article Number	Unit/pack
2507 Dove Blue Opaque	0.75	114 00 115	4
	2.50	114 00 111	2
2606 Medium Brown Opaque	0.75	114 00 011	4
	2.50	114 00 012	2
2607 Dark Brown Opaque	0.75	114 00 009	4
	2.50	114 00 010	2
2703 Charcoal Opaque	0.75	114 00 013	4
	2.50	114 00 014	2
2704 Dusk Grey Opaque	0.75	114 00 015	4
	2.50	114 00 016	2
2708 Pebble Grey Opaque	0.75	114 00 122	4
	2.50	114 00 123	2
2716 Anthracite Grey (RAL 7016) Opaque	0.75	110 00 156	4
	2.50	110 00 158	2
2735 Light Grey (RAL 7035) Opaque	0.75	114 00 143	4
	2.50	114 00 144	2
2742 Traffic Grey A (RAL 7042) Opaque	0.75	114 00 149	4
	2.50	114 00 151	2

78

TIP

With or without?

Film protection with biocides.

Micro-organisms can settle on wood surfaces and cause unattractive discolorations. We offer coating systems with biocidal active ingredients that reliably prevent attacks from mould, algae, etc. The ingredients are adjusted precisely to suit the application, so that any harmful effects on people can be largely eliminated when used properly.

Osmo Country Colour is also available upon request, for a surcharge, with biocidal active ingredients for film protection against algae and fungal attack.

WR Base Coat



Microporous and breathable surface



Reduces swelling and shrinkage



Protects against blue stain, rot and wood-destroying insects



Recoatable after approx. 12 hours



5-6 m²/1 l
1 coat



Impregnation for all Osmo coatings



Strongly water repellent

Osmo WR Base Coat 4001 is a wood preservative for amateur use against wood rotting fungi, wood staining fungi and wood destroying insects on all outside wood which is out of direct ground contact and/or surface water e.g.: facades, windows (inner and outer parts), exterior doors (inner and outer parts), carpports, shutters and balcony railings. Not for indoor application.

Colour code	Can size Litre	Article Number	Unit/pack
4001 Clear	0.75	138 00 001	4
	2.50	138 00 002	2

Methods of Application

Finished surface in 1 day, 1 coat (top coat required)

1. Apply finish onto raw wood approx. 160-200 ml/m². Apply to all sides if possible.
2. Drying time approx. 12 hours (normal climatic conditions, 23 °C/ 50 % rel. humidity). Lower temperatures and/or higher humidity can increase drying time. Ventilate well while drying.
3. Apply a top coat within 3 months with One Coat Only HS^{plus}, Country Colour, Natural Oil Woodstain, Opaque Gloss Wood Stain, Garden Colour, Garden Stain or UV Protection-Oil.

Use biocides carefully. Always read the label and product information before use!



Economical and weatherproof

Craftspeople appreciate the excellent hiding power and the short drying time; end consumers love the highly effective protection and low

susceptibility to dirt and stains. No question about it: Osmo Garden Colour is ideally formulated for its purpose.

A milestone in efficiency

This product stands for simple application, high hiding power and a finished surface in only one day.

Garden Colour





Dries
extremely fast

81

Special advantages

- > Suitable for playground equipment and nursery schools
- > Sprayable
- > Extremely short drying time
- > No priming necessary
- > High hiding power
- > Low susceptibility to dirt and stains



Garden Colour



- Sprayable
- Waterborne
- Water and dirt repellent surface
- Recoatable after approx. 3-4 hours
- 16 m²/1 l 1 coat
- Fast drying
- Low solvent content

Osmo Garden Colour is best suited for all exterior wood: timber cladding, balconies, window shutters, fencing, pergolas, garden sheds, garden furniture and carports.

Colour code	Can size Litre	Article Number	Unit/pack
7103 Signal Yellow (RAL 1003) Opaque	0.75	124 00 040	4
7519 Capri Blue (RAL 5019) Opaque	0.75	131 00 305	4
7530 Flame Red (RAL 3000) Opaque	0.75	131 00 315	4
7629 Mint Green (RAL 6029) Opaque	0.75	131 00 322	4
7283 Pine Green (RAL 6009) Opaque	0.75	131 00 092	4
	2.50	131 00 091	2
7511 Brown Red (RAL 3011) Opaque	0.75	131 00 338	4
	2.50	131 00 340	2
7119 Grey Beige (RAL 1019) Opaque	0.75	131 00 344	4
	2.50	131 00 346	2
7817 Chocolate Brown (RAL 8017) Opaque	0.75	131 00 350	4
	2.50	131 00 352	2
7505 Jet Black (RAL 9005) Opaque	0.75	131 00 326	4
	2.50	131 00 328	2
7716 Anthracite Grey (RAL 7016) Opaque	0.75	131 00 332	4
	2.50	131 00 334	2
7542 Traffic Grey A (RAL 7042) Opaque	0.75	131 00 339	4
	2.50	131 00 341	2
7738 Agate Grey (RAL 7038) Opaque	0.75	131 00 345	4
	2.50	131 00 347	2
7535 Light Grey (RAL 7035) Opaque	0.75	131 00 351	4
	2.50	131 00 353	2
7262 Pure white (RAL 9010) Opaque	0.75	131 00 048	4
	2.50	131 00 047	2
7500 Traffic White* (RAL 9016) Opaque	0.75	131 00 222	4
	2.50	131 00 223	2

Upon request also available in 186 RAL and 1950 NCS colours. Effect, fluorescent and metallic colours are not available.

* Upon request also available in 10 L canisters.

Methods of Application

Finished surface in 1 day, 2 coats

- With Osmo Flat Brush or Microfibre Roller, apply thinly and quickly lap for lap with the grain or in a spray application.
- Leave to dry for approx. 3-4 hours under good ventilation.
- After drying, carry out the second coat, also thin and quickly. For renovations, one coat is sufficient.
- Drying time approx. 12 hours.

Primer



- Waterborne
- Coating protected against mould, algae and fungal attack
- For dimensionally stable / unstable exterior wood
- Recoatable after approx. 3-5 hours
- 12 m²/1 l 1 coat
- Non-drip non-splatter formula
- Very fast drying
- Hides visible knots

Osmo Primer is suitable for any exterior wood, for which a white finish is desired before installation. Ideal for timber cladding, wooden rafters and purlins, roof soffits, gables, balconies, fencing, pergolas, garden sheds, carports and other dimensionally stable and unstable elements.

Colour code	Can size Litre	Article Number	Unit/pack
7000 White opaque	2.50	114 00 168	2

Methods of Application

Finished surface in 1 day, 1 coat (top coat required)

- First coat on raw wood approx. 80 ml/m².
- Drying time approx. 30 minutes, dry to sand or coat after approx. 3-5 hours (normal climatic conditions, 23 °C/ 50 % rel. humidity). Lower temperatures and/or higher humidity can increase drying time. Ventilate well.
- As high quality top coat, a white or light-coloured top coat with Osmo Country Colour or Osmo Garden Colour is recommended.

Polymer Composite Maintenance Oil WPC & Aluminium Cleaner



Based on renewable raw materials	Microporous and breathable surface	Water and dirt repellent surface
Easy to clean and maintain	Recoatable after approx. 8-10 hours	40 m²/1 l 1 coat

High performance concentrate	Deep cleaning power	High coverage
Simple application		

Osmo Polymer Composite Maintenance Oil is suitable as a clear care product for maintaining and restoring weathered Wood Polymer Composites (WPC) and Bamboo Polymer Composites (BPC). Especially suitable for decking, privacy screens and garden furniture made of WPC or BPC. Not suitable for co-extruded surfaces.

Colour code	Can size Litre	Article Number	Unit/pack
030 Clear Satin	1.00	115 00 111	4

Methods of Application

Finished surface in 1 day

1. Prior to application, thoroughly clean the complete surface with water and Osmo WPC & Aluminium Cleaner and leave to dry.
2. With Osmo Flat Brush or Decking Brush, apply very thinly and spread thoroughly.
3. Remove excess material with a clean dry Osmo Decking Brush.
4. Drying time approx. 8-10 hours (normal climatic conditions, 23 °C/ 50 % rel. humidity). Lower temperatures and/or higher humidity can increase drying time. Ventilate well.

Osmo WPC & Aluminium Cleaner was especially developed to clean WPC and BPC decking and other waterproof surfaces in outdoor areas, such as garden furniture and fencing made of synthetic materials and aluminium. Not suitable for co-extruded surfaces.

Colour code	Can size Litre	Article Number	Unit/pack
8021 Clear	1.00	139 00 078	6
	5.00	139 00 079	1

Methods of Application

Finished surface in 1 day

1. Remove debris.
2. Dilute the concentrate with water, 1:20 up to 1:10. Apply to desired areas, loosen deposits with a scrub brush and rinse with clear water. A trial application is absolutely necessary! Do not use undiluted! Always use on the complete area!
3. Reaction time: approx. 10 minutes, afterwards rinse thoroughly with water.
4. Coverage: concentrate, depending on the amount of contamination, diluted with water 1 L = 10-50 m².

Note: not suitable for photovoltaic modules

Ideas without limits. Tinted as requested.

No matter which finish you give your life – Osmo has the suitable colours. The best part: you get to pick your very own colour!

At **Osmo Tinting System** stores, automatic dispensers produce Osmo natural oil-based wood finishes to order. Choose from a nearly endless variety of transparent and opaque colours as well as a range of various sheens.

Osmo **Country Shades**, **Natural Oil Woodstain** and **Wood Wax Finish** can be mixed to any of the 120 opaque colours from the **Elements®** collection inspired by the four elements of nature: Air, Earth, Fire and Water.

In addition to the Elements® colour collection, Osmo Country Shades, Natural Oil Woodstain and Wood Wax Finish can also be mixed to order in 216 RAL Classic and 4800 BS colours directly on tinting machines. NCS, RAL Design and many more colours are available upon request.

Your design ideas have no limits.

Be on the safe side. Sample sachet service.

Offer your customers a special service with Osmo sample sachets. Regardless of whether coloured wood coatings for the interior or exterior – the contents of a sample sachet covers a sample area of approx. 20 x 30 cm. This way, your customer can get an impression of the final results and are definitely on the safe side. And you too.

Contents per sample sachet: 5 ml





Content per box: 20 sachets



TIP

Wood Reviver Power-Gel



-  Restores the natural wood colour
-  Odourless
-  Biodegradable
-  Versatile in use

Osmo Wood Reviver Power-Gel is highly recommended for timber decking, cladding, garden furniture and similar surfaces.

Colour code	Can size Litre	Article Number	Unit/pack
6609 Clear	0.50	139 00 115	6
	2.50*	139 00 129	1
	5.00	139 00 128	1
	10.00	139 00 117	1

* Cleaning brush included.

Methods of Application

Finished surface in 1 day

1. Remove debris.

2. Dampen surface with water.

3. Apply approx. 100 ml/m² on greyed wood.





4. After reaction time, min. 20 minutes, scrub surface with a hard bristle or scrub brush and a lot of water. Surface can be recoated after drying for approx. 48 hours (normal climatic conditions, 23 °C/50 % rel. humidity). Lower temperatures and/or higher humidity can increase drying time.

5. Protect the surface with an Osmo wood finish for exterior use.

Note: Metals (e.g. hinges), sensitive mineral surfaces (e.g. marble) and plants must be protected from direct contact (e.g. cover farm and ornamental plants with a tarpaulin.)

Paint Remover Gel



-  Ideal for removing oil coatings
-  Odourless
-  Biodegradable
-  Versatile in use

Osmo Paint Remover Gel removes old Decking-Oil and wood stains on timber decking and garden furniture made of wood. Ideal for removing oil-based surface finishes on partially weathered timber decking so that an overall oil-free wood surface is achieved.

Colour code	Can size Litre	Article Number	Unit/pack
6611 Clear	0.50	139 00 142	6
	2.50*	139 00 143	1
	5.00	139 00 144	1
	10.00	139 00 145	1

* Cleaning brush included.

Methods of Application

Finished surface in 1 day

1. Remove debris.

2. Apply product thick enough (approx. 200 ml/m²) on the dry surface.

3. Reaction time: up to 60 minutes. Keep surface damp during reaction time (e.g. with a spray bottle).

4. Afterwards scrub the surface with a lot of clear water along the wood grain. Leave to dry for at least 48 hours (normal climatic conditions, 23 °C/50 % rel. humidity). Lower temperatures and/or higher humidity can increase drying time.

5. After drying, inspect the wood surface and repeat the process if necessary.

6. If the wood surface should be re-oiled, the surface must be neutralised and remove greying with Osmo Wood Reviver Power-Gel 6609 after drying.

Note: Cover all areas that should not be treated, such as sensitive plants, porous substrates (e.g. light-coloured pebble dashed concrete, render etc.), aluminium, zinc or lacquered surfaces. Have mop water ready to rinse any surface (e.g. aluminium, zinc or lacquered areas) that accidentally come into contact with gel. Please wear safety gloves and goggles. Residues from Paint Remover Gel can have a negative influence on the drying and adhesive properties of subsequent coatings. Therefore, it is absolutely essential to thoroughly rinse the surface after treatment.

Decking Cleaner



Osmo Decking Cleaner is especially suitable for cleaning any exterior wooden decking as well as for privacy screens, fences and garden furniture made of wood.

Colour code	Can size Litre	Article Number	Unit/pack
8025 Clear	1.00	139 00 150	6

Methods of Application

Finished surface in one day

1. Remove debris from wood surface with a sturdy broom/hand broom.
2. Pour Osmo Decking Cleaner into mop water. (Concentration depends on the amount of contamination 1:25 up to max. 1:1.)
3. Clean wood along the wood grain with a scrub brush (For machine applications on decking, Osmo Decking and Flooring Cleaning Machine is recommended).
4. Coverage depends on the degree of contamination, 1 L = 30 – 100 m²
5. After cleaning, rinse with clear water.

TIP



Decking care made easy – the all-round carefree package

Wood can withstand sun, frost and moisture for many years. However, it still requires protection and care. This especially applies to garden decks because dirt, moisture and moss adhere more easily to horizontal deck boards than to vertical walls. To protect timber decking, Osmo has developed an entire product family. No matter whether you use, for example, **Osmo Decking Cleaner** for routine cleaning or **Paint Remover Gel** for removing existing oil finishes, all care products are specifically formulated for the properties of wood and achieve perfect results.

Garden Furniture Maintenance Kit



Osmo Garden Furniture Maintenance Kit is suitable for maintaining wood in outdoor areas. Highly recommended for garden furniture.

Please follow the work instructions for each individual product.

Product	Article Number	Unit/pack
Garden Furniture Maintenance Kit	139 00 125	1

Methods of Application

Finished surface in 2 days, 2 coats

1. Remove debris with the stiff brush.
2. Even out damages in wood with the buffing fleece.
3. Dampen surface with water.
4. Apply Wood Reviver Power-Gel and rub into wood with the stiff brush.
5. Rinse with clear water and leave to dry completely (min. 24 hours).
6. Apply the first coat of Decking-Oil Teak, Clear on wood.
7. Mistakes in the wet coating can be corrected up to 15 minutes after the first application.
8. Drying time approx. 12 hours (normal climatic conditions, 23 °C/50 % rel. humidity). Lower temperatures and/or higher humidity can increase drying time. Allow for good ventilation.
9. Apply the second coat Decking-Oil Teak, Clear.
10. Drying time approx. 12 hours; see point 8.



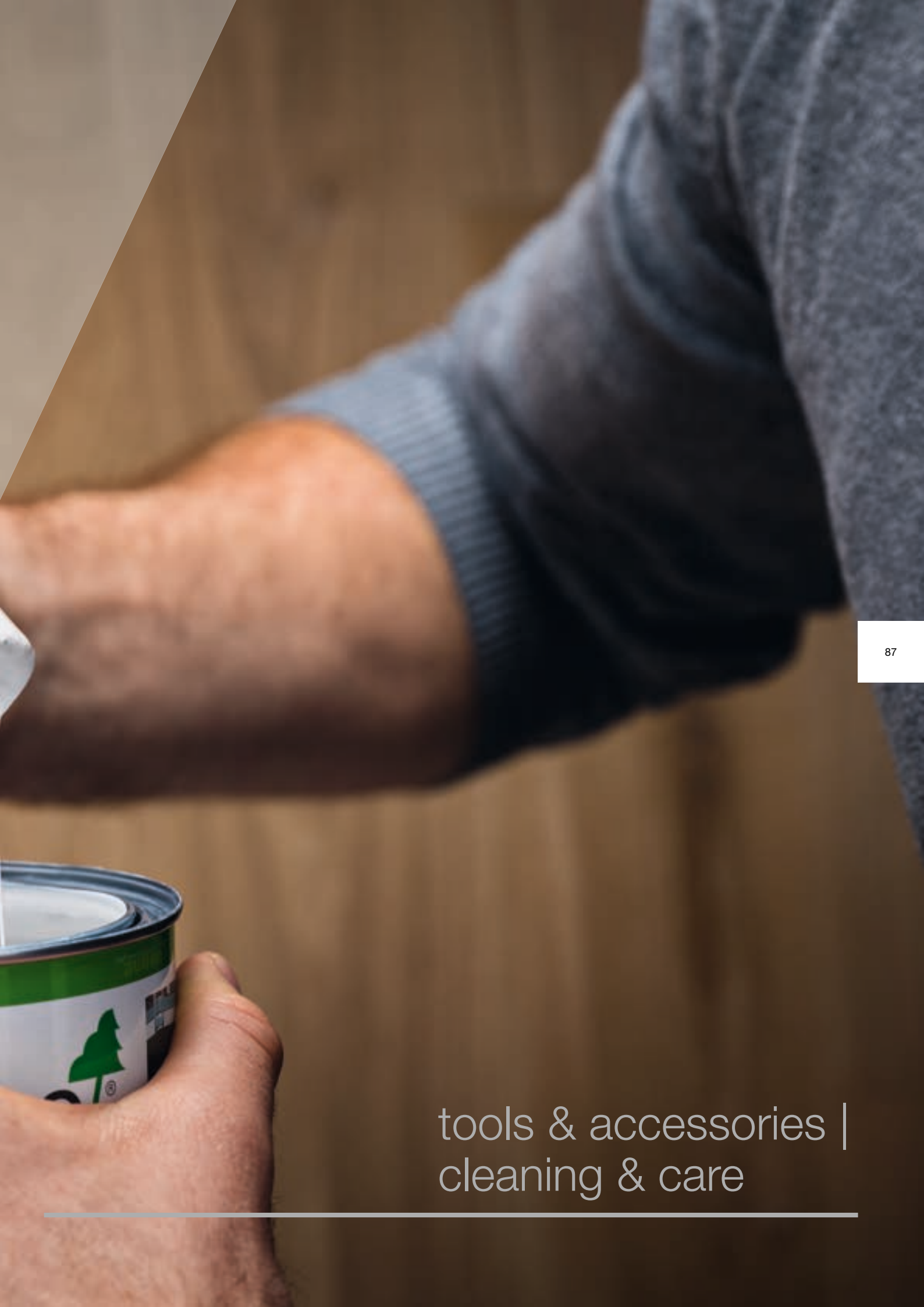

tools & accessories |
cleaning & care

Tools with a system.

Work more efficiently thanks to Quick Connect.



88

Our range of tools has been carefully thought through, down to the smallest detail. This means you can count on maximum efficiency. Quick Connect technology integrated in Osmo System Telescopic Handle enables a connection to rollers, brushes, pad holders and so on with just a flick of the wrist.

But, many other products in our range of tools ease work noticeably, like Osmo FloorXcenter, HandXcenter as well as Osmo Decking and Flooring Cleaning Machine for the professional preparation of floors. More efficiency, more project success.

The best application thanks to the best quality.



Perfect brush.
For perfect results.

Simple application and perfect visual results – thanks to brushes, whose bristles are tightly bound in a matrix.



Simply clever.
The disposable tray insert.

Cleaning tools is generally very time-consuming. To shorten this process down, we have developed a disposable tray insert, which can be thrown away after using. Simply clever.



Material savings and an even coat.
Thanks to Osmo Microfibre Roller.

The best application is one that ensures an even coat and low material consumption. No question: Our Microfibre Roller fulfils both requirements.

System Telescopic Handle



Product	Article Number	Unit/pack
System Telescopic Handle 120-200 cm	140 00 312	1

Floor Roller Set



Product	Article Number	Unit/pack
Floor Roller Set	140 00 230	2
Replacement roller in Fresh Box	140 00 173	4
Replacement roller value pack (12 pcs.)	140 00 194	1
Tray inserts for Floor Roller Set (10 pcs.)	140 00 232	1

Floor Brush



Product	Article Number	Unit/pack
Floor Brush with handle (220 mm)	140 00 305	6
Floor Brush with handle (400 mm)	140 00 310	1

Pad Holder with joint



Product	Article Number	Unit/pack
Pad Holder with joint	140 00 238	6
Superpad rectangular white	140 00 265	10
Superpad rectangular red	140 00 266	10
Superpad rectangular green	140 00 267	10
Coating Applicator Fleece	140 00 272	15

Cleaning Kit for Floors



Product	Article Number	Unit/pack
Cleaning Kit for Floors	140 00 262	4
Dust-Mop	140 00 050	1
Micro-Mop plush	140 00 055	1
Active Fibre Cloth	140 00 060	1

Decking Cleaning Brush with handle



Product	Article Number	Unit/pack
Decking Cleaning Brush with handle	140 00 237	6

Roller and Brush Set



Product	Article Number	Unit/pack
Roller and Brush Set	140 00 171	4
Tray inserts for Roller and Brush Set (10 pcs.)	140 00 172	1
Replacement roller value pack (10 pcs.)	140 00 198	1
Refill pack Microfibre Rollers (2 pcs.)	140 00 182	6

Decking Brush with handle



Product	Article Number	Unit/pack
Decking Brush with handle (150 mm)	140 00 300	6

91

Decking Brush Set



Product	Article Number	Unit/pack
Decking Brush Set	140 00 233	4
Tray Inserts for Decking Brush Set (10 pcs.)	140 00 235	1

HandXcenter



- 
Easy working
- 
Fast and efficient working
- 
Ideal for commercial interiors

Osmo HandXcenter is suitable for finishing and staining wood surfaces as well as the initial care and refreshing of oiled wood surfaces. Solely intended for use inside of buildings.

Product	Article Number	Unit/pack
HandXcenter	140 00 261	1
Drive disc for HandXcenter	140 00 263	1
White pads for HandXcenter 218 mm	140 00 264	5

FloorXcenter



- 
Fast and efficient working
 - 
Easy working
 - 
Pads for various applications
- 
Ideal for commercial interiors

Osmo FloorXcenter is suitable for the cleaning, initial care and refreshing or upkeep of oiled wooden flooring as well as for finishing and staining. Solely intended for use inside of buildings.

Product	Article Number	Unit/pack
FloorXcenter	140 00 240	1
FloorXcenter White Pad	140 00 241	5
FloorXcenter Red Pad	140 00 242	5
FloorXcenter Green Pad	140 00 259	5
FloorXcenter Microfibre Pad	140 00 243	5
FloorXcenter Brush Ring	140 00 244	1

Methods of Application

White pad – loosens common household contaminations (ideal for coating flooring and re-oiling with Polyx®-Oil)

Red pad – removes especially tough deposits, also suitable for intermediate sanding.

Green pad – cleans intensively and rubs in 2-component products.

Microfibre pad – picks dirt up.



Decking and Flooring Cleaning Machine



Osmo Decking and Flooring Cleaning Machine is suitable for loosening and removing deposits in indoor and outdoor areas in one step. Ideal for the intensive cleaning and degreasing of timber decking and for the deep cleaning of wooden flooring.

Product	Article Number	Unit/pack
Decking and Flooring Cleaning Machine	140 00 250	1
Abrasive Brush	140 00 251	1
Universal Brush	140 00 252	1
Edge Brush universal	140 00 254	1
Edge Brush abrasive	140 00 256	1



Flat Brush



Product	Article Number	Unit/pack
Flat Brush 25 mm	140 00 175	12
Flat Brush 50 mm	140 00 176	12
Flat Brush 60 mm	140 00 177	12
Flat Brush 80 mm	140 00 183	12
Flat Brush 100 mm	140 00 178	12

Hand Pad Holder



Product	Article Number	Unit/pack
Hand Pad Holder 85 x 135 mm	140 00 260	6
Superpad rectangular white 95 x 155 mm	140 00 268	10
Superpad rectangular red 95 x 155 mm	140 00 269	10
Superpad rectangular green 95 x 155 mm	140 00 270	10
Coating Applicator Fleece 95 x 155 mm	140 00 271	15

Osmo Oil Finish Application Set



Product	Article Number	Unit/pack
Osmo Oil Finish Application Set	140 00 273	4

Content

- > 1 Hand Pad Holder 85 x 135 mm, incl. hook and loop fastener
- > 2 Oil Finish Application Fleecees 95 x 155 mm
- > Roller tray with ridged area 22 x 20 cm
- > 3 Tray inserts

Rubber Scraper



Product	Article Number	Unit/pack
Rubber Scraper 220 mm	140 00 201	1
Rubber Scraper 350 mm	140 00 202	1

Easy Pads

Specialised cloths for cleaning, maintaining and polishing oiled or waxed as well as varnished or lacquered wood surfaces. Easy Pads are not only easy and convenient in application, but they also have a high cleaning power.



Product	Article Number	Unit/pack
Easy Pads (10 pcs.)	140 00 160	5
Easy Pads (bulk pack) (200 pcs.)	140 00 156	1

Double Blade Scraper



Product	Article Number	Unit/pack
Double Blade Scraper	140 00 187	1

Stirring Stick



Product	Article Number	Unit/pack
Stirring Stick	140 00 006	10

94

Brush Cleaner and Thinner



Osmo Brush Cleaner and Thinner is ideal for the cleaning of work tools after applying Osmo wood coatings or other solvent-based oil or synthetic resin paints, also suitable as a thinner for solvent-based paints.

Colour code	Can size Litre	Article Number	Unit/pack
8000 Clear	0.50	139 00 185	6
	1.00	139 00 001	6
	25.00	139 00 006	1

Questions and Answers

Notes on the use of oil-based coatings

Cloths saturated with liquid product should either be washed out immediately or stored in a closed airtight metal container. (Danger of self-ignition!)

Can I change the colour of wooden flooring?

Yes, this is possible with many products from Osmo. Osmo Polyx®-Oil Original, Wood Wax Finish and Oil Stain are ideal for staining floors. The correct application for each product should always be observed. After thoroughly drying, apply one thin coat of a clear Polyx®-Oil as a top coat.

How do I prepare the surface of wooden flooring?

The surface should be sanded with the wood grain, the final sanding step should be with grit 120 –150 sandpaper. Any scratches should be carefully removed.

What do I do if part of the wood surface is damaged?

Unlike many traditional lacquers and varnishes, damaged areas treated with Osmo products can be sanded and recoated with the same products without leaving any visible transitions.

Do I have to sand between coats?

You should always assess the surface before applying the second coat, as sanding between coats may be necessary.

Is there anything I should pay attention to when coating wooden floors?

Due to their density and content of wood extractives, some hardwoods, such as Jatoba and Merbau, can absorb little product. For such wood species, we recommend a clear coat with Osmo Wood Wax Finish Clear Extra Thin, which deeply penetrates wood pores.

What happens if too much material is applied to flooring?

If you apply too much material, the drying time will prolong considerably. If this happens, provide additional ventilation by opening windows and doors so that the product can dry naturally through oxidation. If damage occurs to the surface, repair the surface as described above.

What happens if too little material is applied to flooring?

If you have applied too little material, watermarks may appear and the wood may dry out or look dull. In such cases, apply another thin coat of the already applied Osmo Polyx®-Oil.

Can Osmo coatings in various colours be mixed with each other?

Yes, the colours of one respective product can be mixed in any ratio. Furthermore, Osmo Wood Wax Finish, Spray-Wax, Country Colour, Garden Colour, Natural Oil Woodstain and Country Shades can be mixed to order in RAL, NCS or custom colours.

When is the surface dry?

Drying times for each product can be found on the respective product information or product label. In general, the drying time is between 8-10 hours. The surface dries through oxidation and absorption. Please provide sufficient ventilation and air circulation.

When are floors treated with Osmo Polyx®-Oil accessible again, and when can I put my furniture back in the room?

Freshly coated floor surfaces are accessible as soon as Polyx®-Oil has dried for approx. 24 hours. Furniture with legs, which allows air to circulate beneath it, can also be placed on the flooring after approx. 24 hours. Objects under which air cannot circulate, such as rugs or mats, should not be placed on the floor for at least one week, after which Polyx®-Oil should be completely cured.

Does flooring have to be polished after the top coat with Osmo Polyx®-Oil has been applied?

No, at this stage no further floor treatment is necessary. However, the surface can be polished with a single disc machine (white pad) once completely dry. If more sheen is desired, the floor can be treated with Osmo Liquid Wax Cleaner after one day at the earliest and then polished.

How do I maintain flooring?

This all depends on how it is used. For routine and gentle mopping, we recommend adding Osmo Wash and Care to mop water. This is sold individually and in Osmo Cleaning Kit for Floors. Optimal tools for flooring upkeep are found in the Osmo Cleaning Kit for Floors. If flooring starts to look dull, simply refresh it with Osmo Liquid Wax Cleaner. This can be done on small areas, e.g. near doors or on high traffic areas, without any visible transitions. If the signs of wear are more substantial, flooring should be recoated with the same Osmo product.

Why does the finished surface look different to the colour swatch on the can?

Colours depicted on the printed label can always differ to the real colour applied to wood, as coloured coatings look different on various substrates. Therefore, we always recommend carrying out a trial application on a suitable area on the wood to be coated. For such trial applications, Osmo offers sample sachets in individual colours.

What properties must the wood substrate have?

Wooden substrates must be clean, dry (for exterior coatings: moisture content max. 20 %) (for interior coatings: moisture content max. 18 %) and frost-free.

What does wood treated with Osmo products smell like?

After curing, wood flooring will still have the faint smell of wood, natural oils and waxes. As solvent, we use dearomatised white spirit, which is less harmful than so-called eco-solvents, such as citrus oils. After fully curing, white spirit dissipates 100 %.

OUR PRODUCTS

> CLADDING

Cladding profiles
Coloured cladding
Accessories

> FLOORING

Solid wood flooring
Concept-Flooring
Creativ-Flooring

> COATING SYSTEMS

For the interior and exterior
Wood protection and care

> INTERIOR WOOD

Solid wood profiles
Framing wood
Laths

> EDGE-GLUED PANELS

Solid wood panels
Work surfaces
Furniture doors

> MOULDINGS

Skirting boards
Mouldings for walls and ceilings
Decorative mouldings

> DECKING

Wood
Ceramic
BPC

> SCREENS

Wood
Sound protection
Aluminium/BPC

Osmo Holz und Color GmbH & Co. KG

Affhüppen Esch 12
D-48231 Warendorf

Postfach 110161
D-48203 Warendorf

Telefon +49 (0)2581/922-100
Telefax +49 (0)2581/922-200

www.osmo.com
info@osmo.de

Your local Osmo dealer:

OSMO UK

Smeaton Close
Unit 24 Anglo Business Park
Aylesbury, Bucks HP19 8UP
Phone: 01296 481 220, www.osmouk.com

